

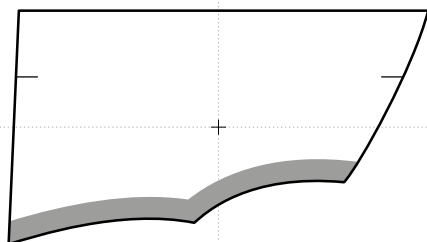

ateliér
kreativ

ADAM



3,5 mm

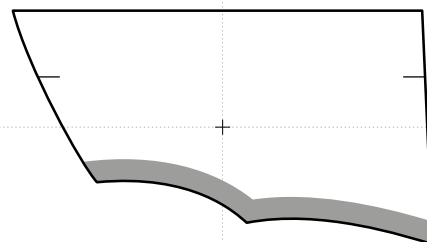

ADELA

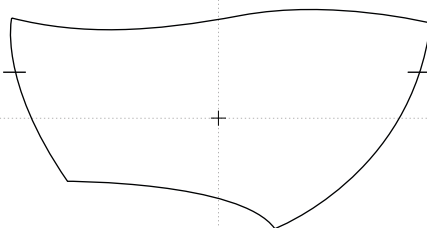

1,5 mm

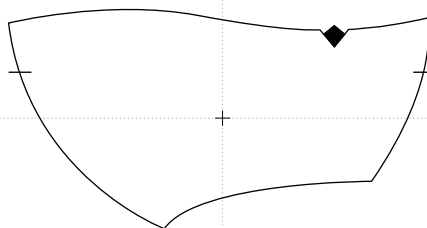

ADINA

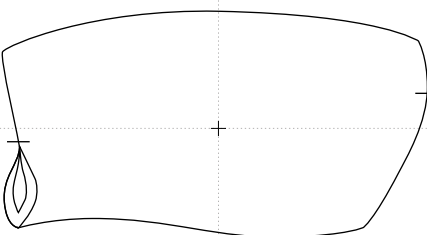

0 mm

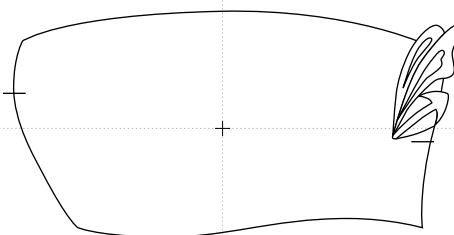

ADRIANA

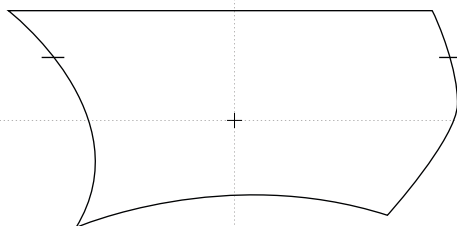

1 mm

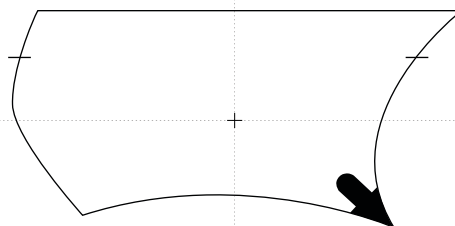

Tyto kreativní tvary brýlových čoček byly navrženy a vyrobeny v ateliéru kreativ při společnosti EYE 2000 s.r.o. a jsou chráněny Úřadem průmyslového vlastnictví jako průmyslový vzor.
These creative glasses lens shapes were designed and produced by ateliér kreativ by EYE 2000 s.r.o. company and are patented and protected by the Authority of the Industrial Property.

EYE 2000 s.r.o. / Ohmova 271 / 109 00 Praha 10 / Czech Republic / Provozovna / Polubenská 614 / 468 61 Desná / Czech Republic
T +420 271 961 170 / www.eye2000.cz / info@eye2000.cz



ateliér
kreativ

AGATA

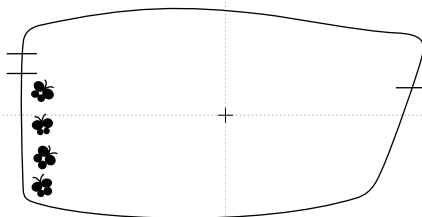

1,5 mm

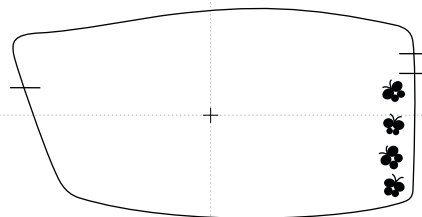

AGNES

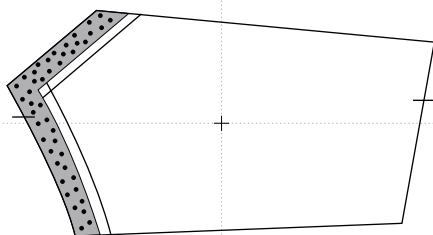

1,5 mm

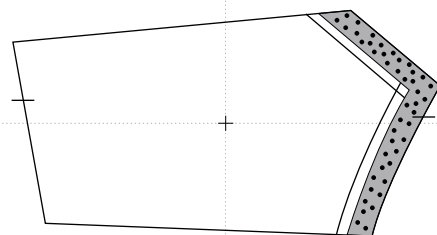

ALBERT

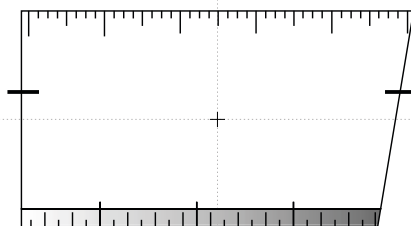

1,7 mm

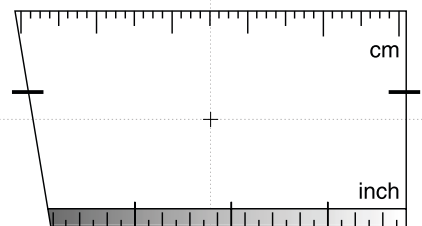

ALENKA

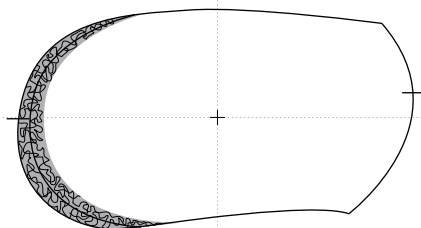

0 mm

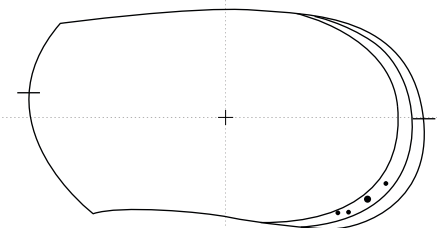

Tyto kreativní tvary brýlových čoček byly navrženy a vyrobeny v ateliéru kreativ při společnosti EYE 2000 s.r.o. a jsou chráněny Úřadem průmyslového vlastnictví jako průmyslový vzor. These creative glasses lens shapes were designed and produced by ateliér kreativ by EYE 2000 s.r.o. company and are patented and protected by the Authority of the Industrial Property.

EYE 2000 s.r.o. / Ohmova 271 / 109 00 Praha 10 / Czech Republic / Provozovna / Polubenská 614 / 468 61 Desná / Czech Republic
T +420 271 961 170 / www.eyeye2000.cz / info@eyeye2000.cz



atelier
kreativ

ALES

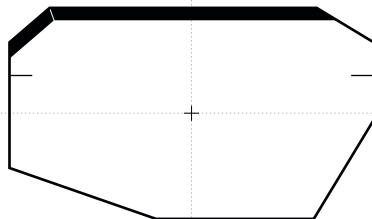

0 mm

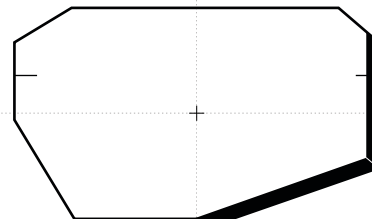

ALEX

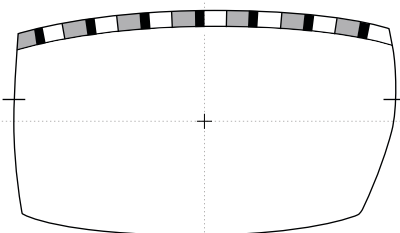

0 mm

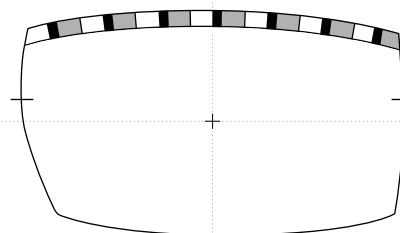

ALEXANDRA

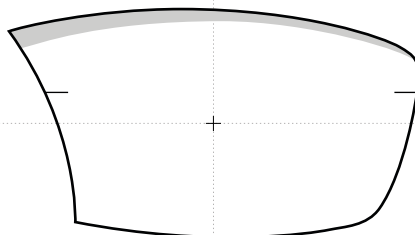

0,5 mm

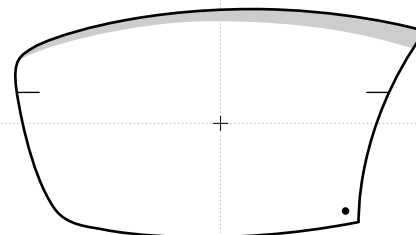

AMALKA

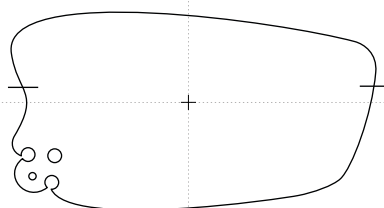

0,5 mm

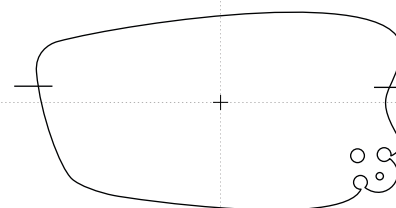

Tyto kreativní tvary brýlových čoček byly navrženy a vyrobeny v ateliéru kreativ při společnosti EYE 2000 s.r.o. a jsou chráněny Úřadem průmyslového vlastnictví jako průmyslový vzor.
These creative glasses lens shapes were designed and produced by atelier kreativ by EYE 2000 s.r.o. company and are patented and protected by the Authority of the Industrial Property.

EYE 2000 s.r.o. / Ohmova 271 / 109 00 Praha 10 / Czech Republic / Provozovna / Polubenská 614 / 468 61 Desná / Czech Republic
T +420 271 961 170 / www.eye2000.cz / info@eye2000.cz



atelier
kreativ

AMELIE

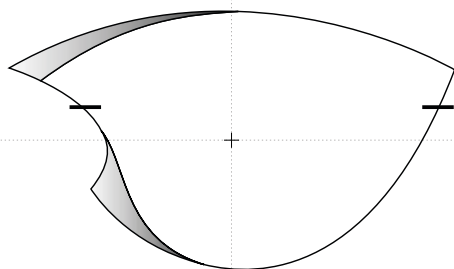

2,2 mm

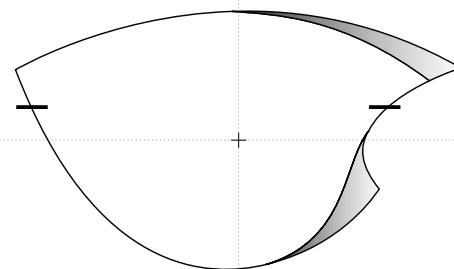

ANDREA

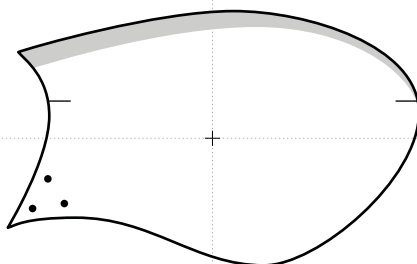

0,5 mm

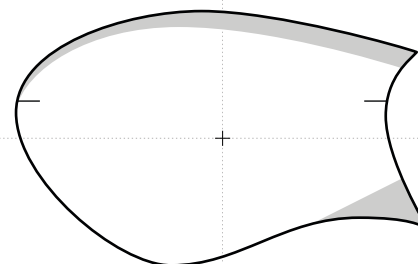

ANDREJ

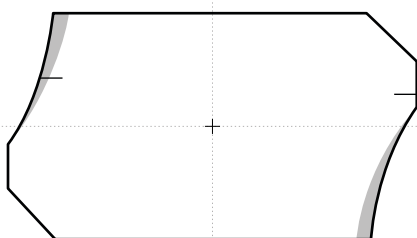

0 mm

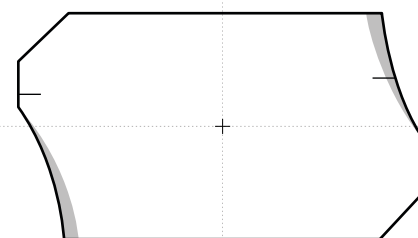

ANEZKA I.

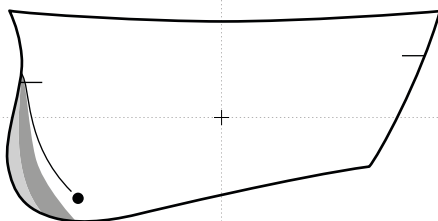

2,5 mm

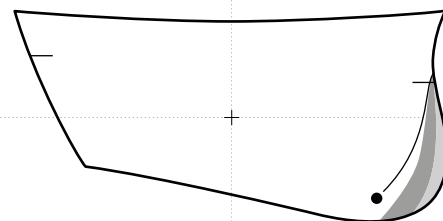

Tyto kreativní tvary brýlových čoček byly navrženy a vyrobeny v ateliéru kreativ při společnosti EYE 2000 s.r.o. a jsou chráněny Úřadem průmyslového vlastnictví jako průmyslový vzor. These creative glasses lens shapes were designed and produced by atelier kreativ by EYE 2000 s.r.o. company and are patented and protected by the Authority of the Industrial Property.

EYE 2000 s.r.o. / Ohmova 271 / 109 00 Praha 10 / Czech Republic / Provozovna / Polubenská 614 / 468 61 Desná / Czech Republic
T +420 271 961 170 / www.eye2000.cz / info@eye2000.cz



ateliér
kreativ

ANEZKA II.

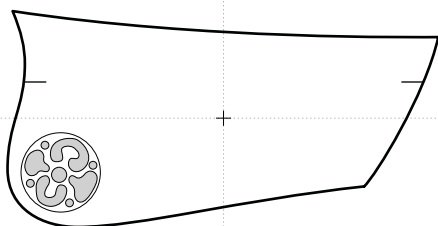

2,5 mm

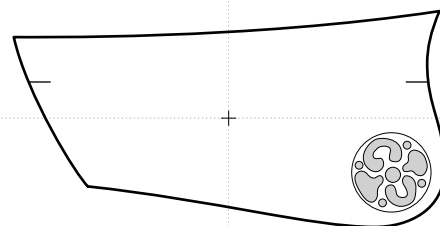

ANITA

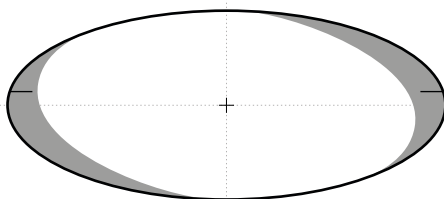

0,5 mm

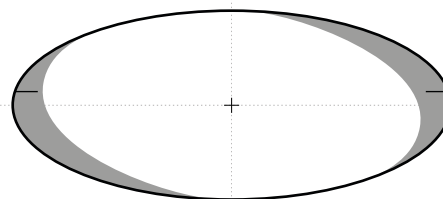

ANNA

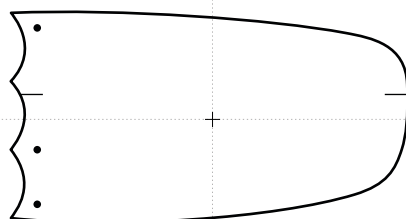

0 mm

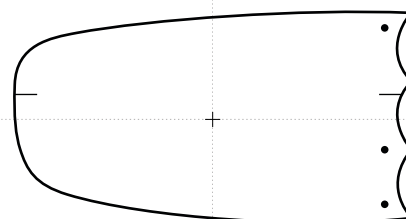

ANNABELA

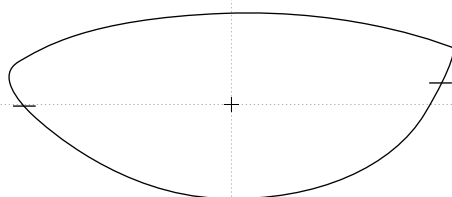

1,6 mm

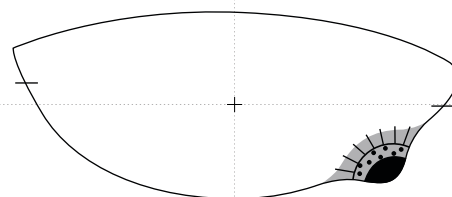

Tyto kreativní tvary brýlových čoček byly navrženy a vyrobeny v ateliéru kreativ při společnosti EYE 2000 s.r.o. a jsou chráněny Úřadem průmyslového vlastnictví jako průmyslový vzor.
These creative glasses lens shapes were designed and produced by ateliér kreativ by EYE 2000 s.r.o. company and are patented and protected by the Authority of the Industrial Property.

EYE 2000 s.r.o. / Ohmova 271 / 109 00 Praha 10 / Czech Republic / Provozovna / Polubenská 614 / 468 61 Desná / Czech Republic
T +420 271 961 170 / www.eye2000.cz / info@eye2000.cz



atelier
kreativ

ANNALIZA

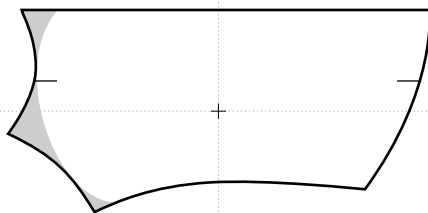

1,5 mm

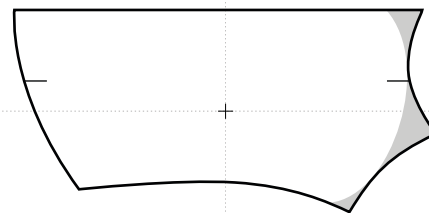

ANTIMONA

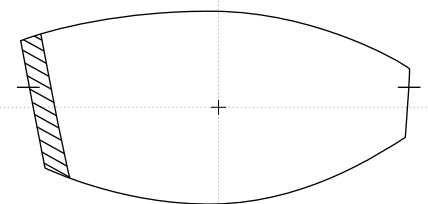

0 mm

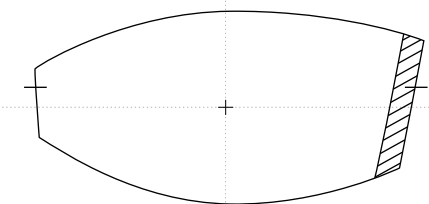

APOLENA

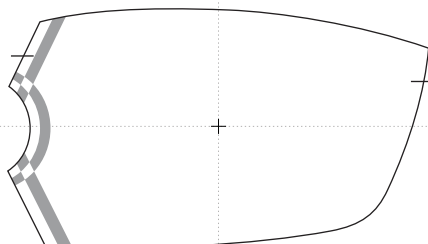

1 mm

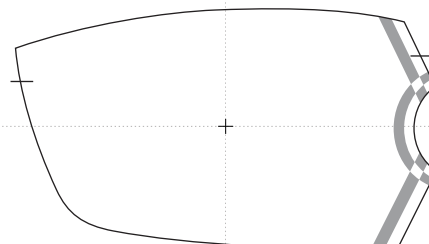

ARIEL

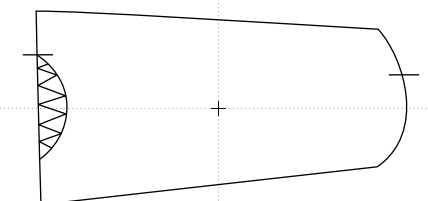

0,5 mm

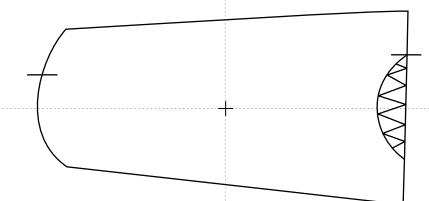

Tyto kreativní tvary brýlových čoček byly navrženy a vyrobeny v ateliéru kreativ při společnosti EYE 2000 s.r.o. a jsou chráněny Úřadem průmyslového vlastnictví jako průmyslový vzor. These creative glasses lens shapes were designed and produced by atelier kreativ by EYE 2000 s.r.o. company and are patented and protected by the Authority of the Industrial Property.

EYE 2000 s.r.o. / Ohmova 271 / 109 00 Praha 10 / Czech Republic / Provozovna / Polubenská 614 / 468 61 Desná / Czech Republic
T +420 271 961 170 / www.eye2000.cz / info@eye2000.cz



ateliér
kreativ

ARJANA

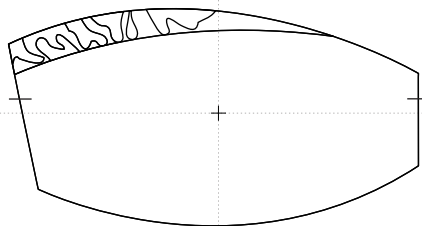

0 mm

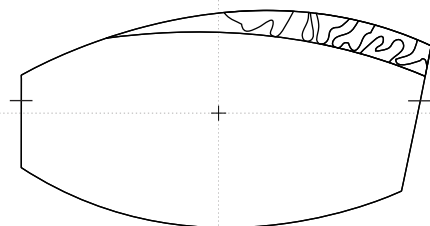

ARSENICA

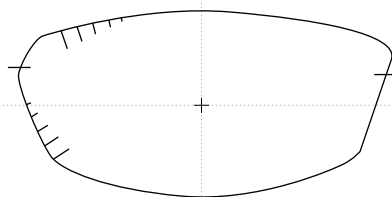

0,5 mm

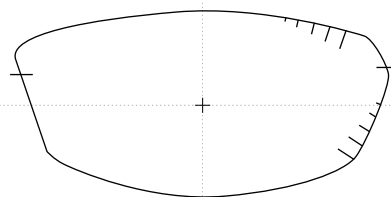

ARTUR

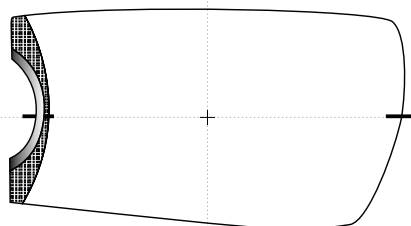

0 mm

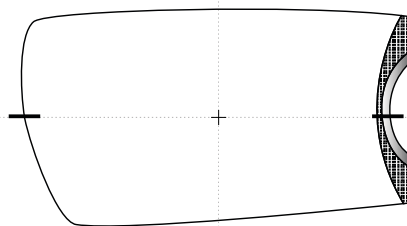

ASTRID

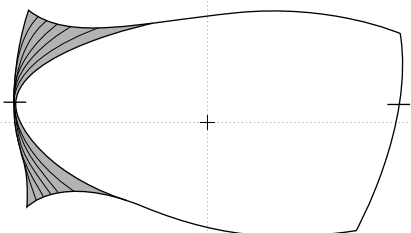

0,6 mm

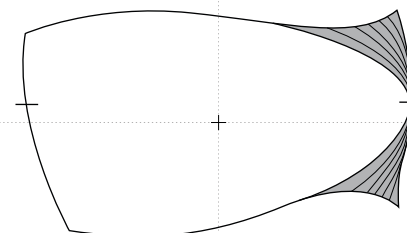

Tyto kreativní tvary brýlových čoček byly navrženy a vyrobeny v ateliéru kreativ při společnosti EYE 2000 s.r.o. a jsou chráněny Úřadem průmyslového vlastnictví jako průmyslový vzor.
These creative glasses lens shapes were designed and produced by ateliér kreativ by EYE 2000 s.r.o. company and are patented and protected by the Authority of the Industrial Property.

EYE 2000 s.r.o. / Ohmova 271 / 109 00 Praha 10 / Czech Republic / Provozovna / Polubenská 614 / 468 61 Desná / Czech Republic
T +420 271 961 170 / www.eye2000.cz / info@eye2000.cz



ateliér
kreativ

AURA

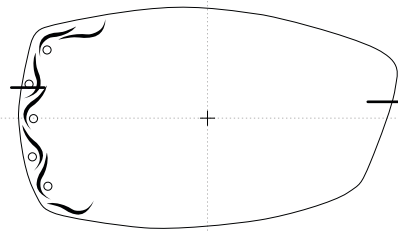

0,7 mm

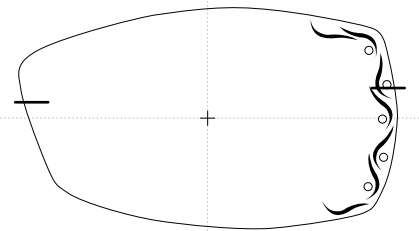

AUREA

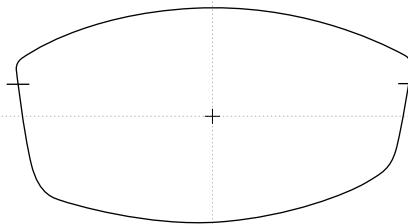

0,5 mm

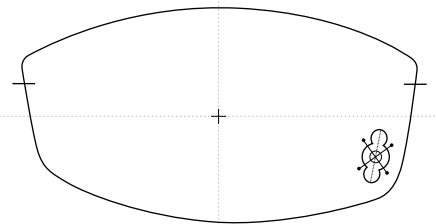

BARBORA

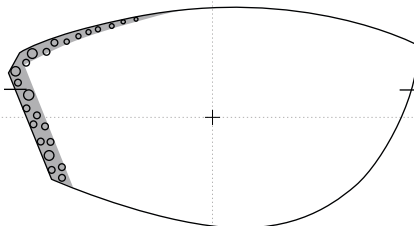

0,9 mm

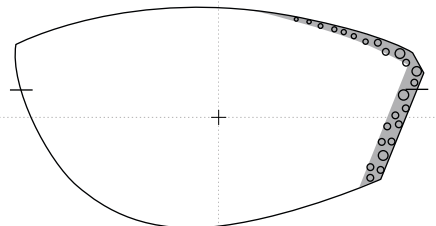

BARIUS

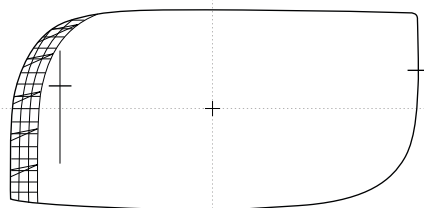

0 mm

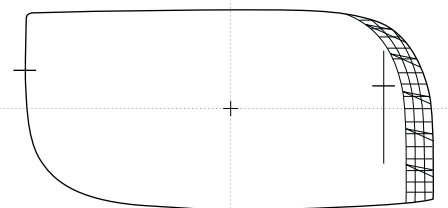

Tyto kreativní tvary brýlových čoček byly navrženy a vyrobeny v ateliéru kreativ při společnosti EYE 2000 s.r.o. a jsou chráněny Úřadem průmyslového vlastnictví jako průmyslový vzor.
These creative glasses lens shapes were designed and produced by ateliér kreativ by EYE 2000 s.r.o. company and are patented and protected by the Authority of the Industrial Property.

EYE 2000 s.r.o. / Ohmova 271 / 109 00 Praha 10 / Czech Republic / Provozovna / Polubenská 614 / 468 61 Desná / Czech Republic
T +420 271 961 170 / www.eyeye2000.cz / info@eyeye2000.cz



atelier
kreativ

BARUNKA

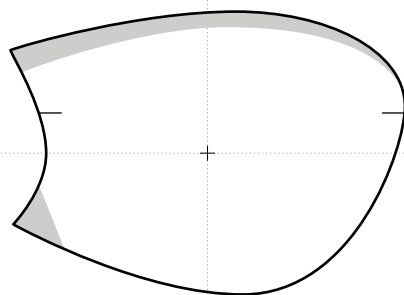

0 mm

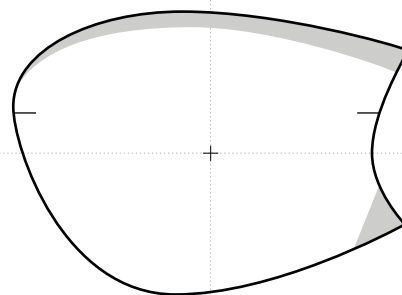

BEATA

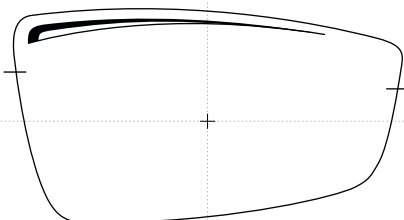

0,5 mm

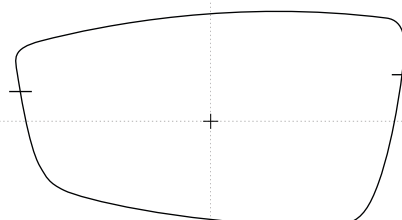

BEATRICE

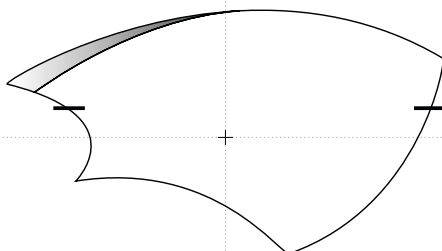

1,8 mm

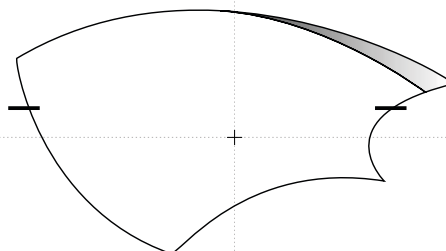

BELA

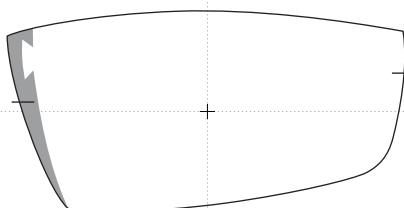

0 mm

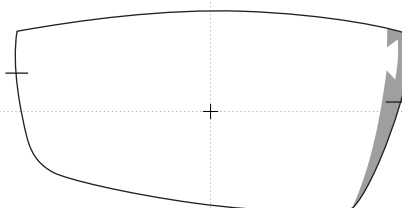

Tyto kreativní tvary brýlových čoček byly navrženy a vyrobeny v ateliéru kreativ při společnosti EYE 2000 s.r.o. a jsou chráněny Úřadem průmyslového vlastnictví jako průmyslový vzor.
These creative glasses lens shapes were designed and produced by atelier kreativ by EYE 2000 s.r.o. company and are patented and protected by the Authority of the Industrial Property.

EYE 2000 s.r.o. / Ohmova 271 / 109 00 Praha 10 / Czech Republic / Provozovna / Polubenská 614 / 468 61 Desná / Czech Republic
T +420 271 961 170 / www.eye2000.cz / info@eye2000.cz



ateliér
kreativ

BENEDIKT

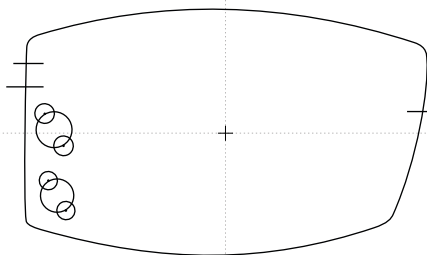

0,5 mm

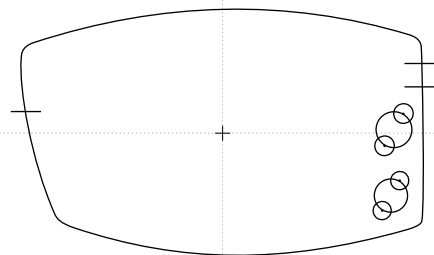

BERAN

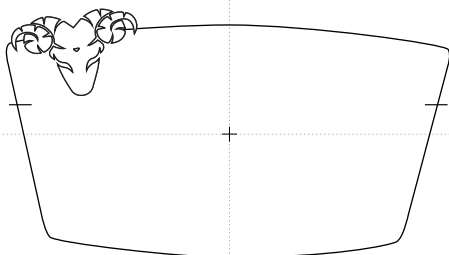

1,5 mm

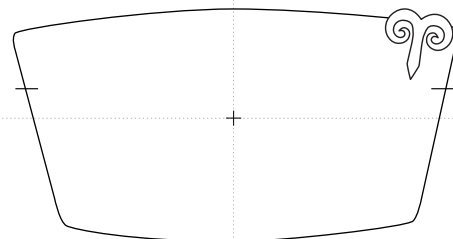

BERENIKA

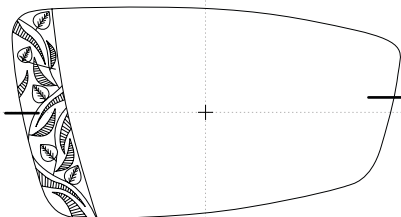

1 mm

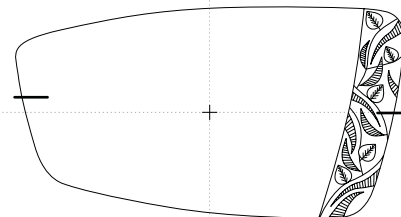

BERYL

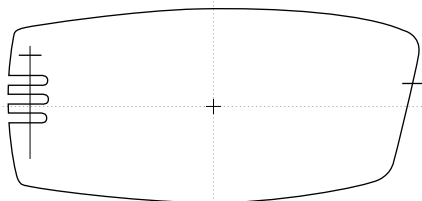

1 mm

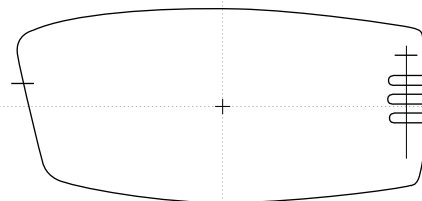

Tyto kreativní tvary brýlových čoček byly navrženy a vyrobeny v ateliéru kreativ při společnosti EYE 2000 s.r.o. a jsou chráněny Úřadem průmyslového vlastnictví jako průmyslový vzor.
These creative glasses lens shapes were designed and produced by ateliér kreativ by EYE 2000 s.r.o. company and are patented and protected by the Authority of the Industrial Property.

EYE 2000 s.r.o. / Ohmova 271 / 109 00 Praha 10 / Czech Republic / Provozovna / Polubenská 614 / 468 61 Desná / Czech Republic
T +420 271 961 170 / www.eyeye2000.cz / info@eyeye2000.cz



atelier
kreativ

BERTA

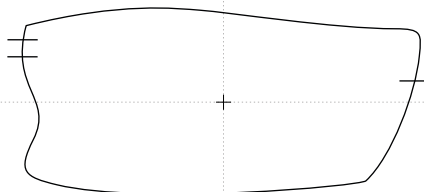

0,5 mm

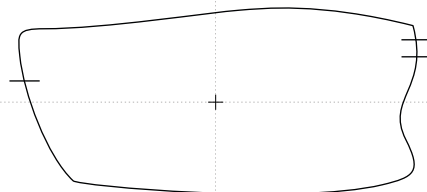

BETYNKA



0 mm

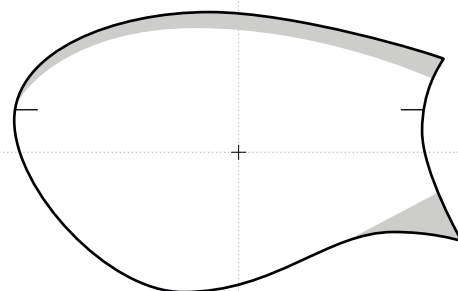

BIANKA

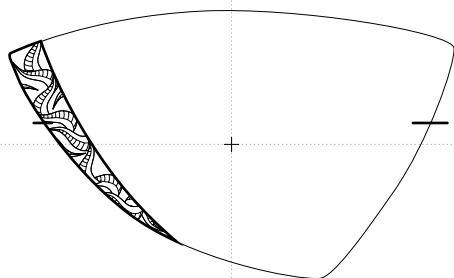

3 mm

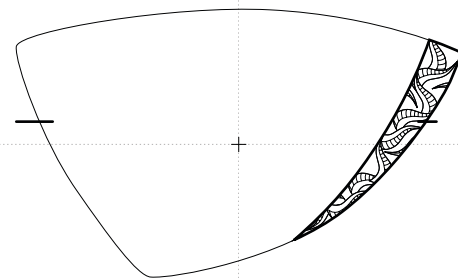

BLANKA

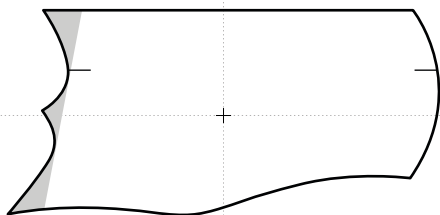

0,5 mm

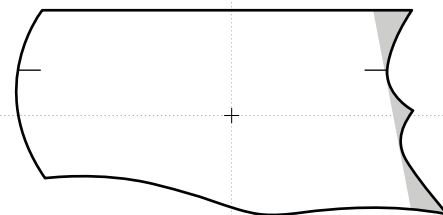

Tyto kreativní tvary brýlových čoček byly navrženy a vyrobeny v ateliéru kreativ při společnosti EYE 2000 s.r.o. a jsou chráněny Úřadem průmyslového vlastnictví jako průmyslový vzor.
These creative glasses lens shapes were designed and produced by atelier kreativ by EYE 2000 s.r.o. company and are patented and protected by the Authority of the Industrial Property.

EYE 2000 s.r.o. / Ohmova 271 / 109 00 Praha 10 / Czech Republic / Provozovna / Polubenská 614 / 468 61 Desná / Czech Republic
T +420 271 961 170 / www.eye2000.cz / info@eye2000.cz



ateliér
kreativ

BLEDULE

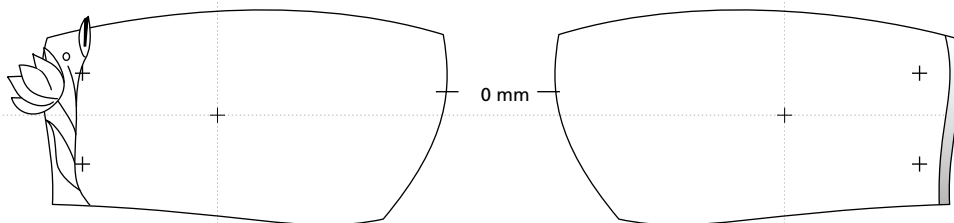

BLIZENCI

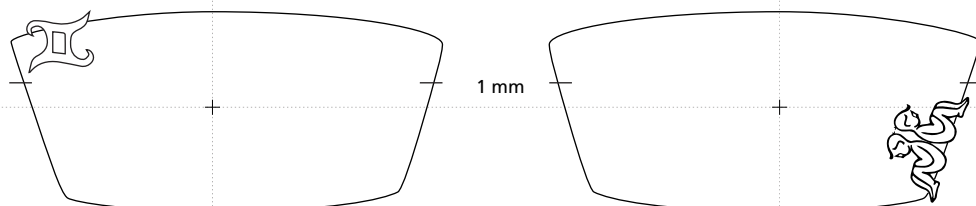

BORA

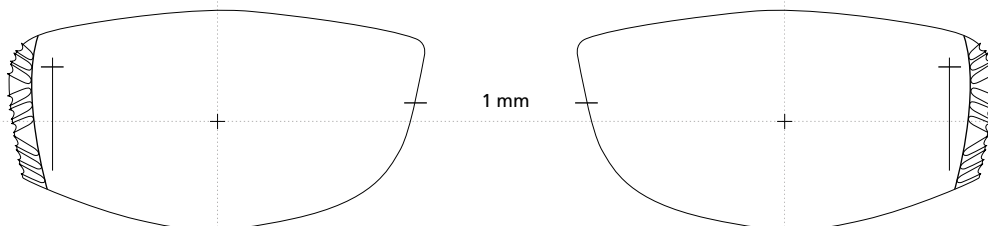

BORIA

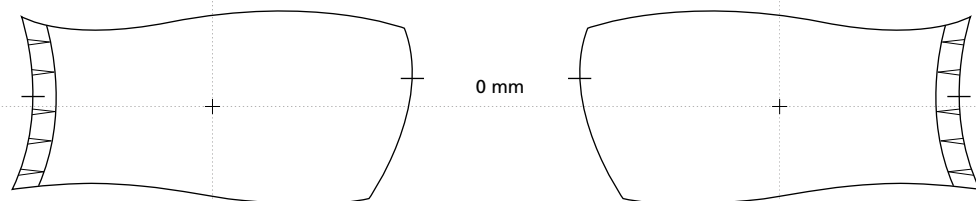

Tyto kreativní tvary brýlových čoček byly navrženy a vyrobeny v ateliéru kreativ při společnosti EYE 2000 s.r.o. a jsou chráněny Úřadem průmyslového vlastnictví jako průmyslový vzor. These creative glasses lens shapes were designed and produced by ateliér kreativ by EYE 2000 s.r.o. company and are patented and protected by the Authority of the Industrial Property.

EYE 2000 s.r.o. / Ohmova 271 / 109 00 Praha 10 / Czech Republic / Provozovna / Polubenská 614 / 468 61 Desná / Czech Republic
T +420 271 961 170 / www.eyeye2000.cz / info@eyeye2000.cz



ateliér
kreativ

BOZENKA

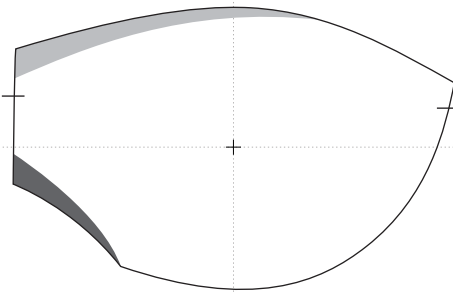

1 mm

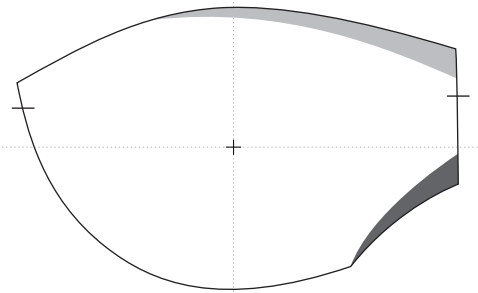

BRENDA

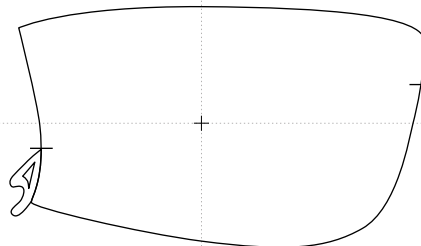

0,5 mm

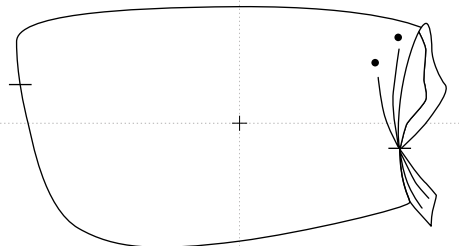

BRIGITA

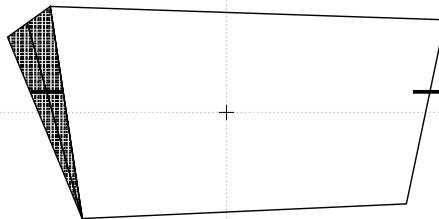

2,2 mm

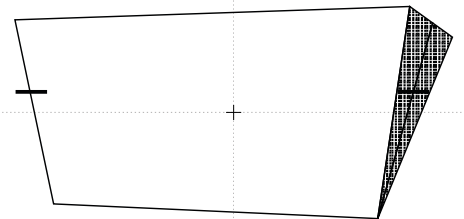

BYK

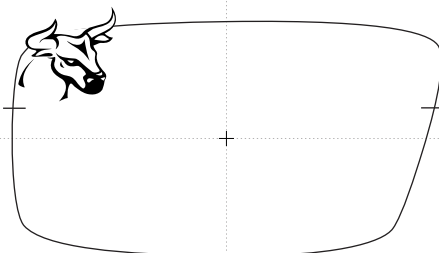

1 mm

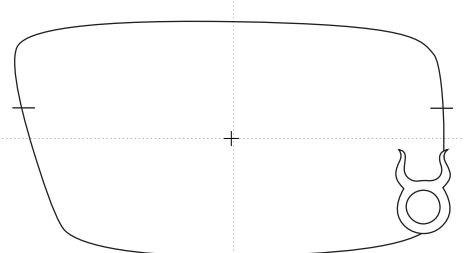

Tyto kreativní tvary brýlových čoček byly navrženy a vyrobeny v ateliéru kreativ při společnosti EYE 2000 s.r.o. a jsou chráněny Úřadem průmyslového vlastnictví jako průmyslový vzor.
These creative glasses lens shapes were designed and produced by ateliér kreativ by EYE 2000 s.r.o. company and are patented and protected by the Authority of the Industrial Property.

EYE 2000 s.r.o. / Ohmova 271 / 109 00 Praha 10 / Czech Republic / Provozovna / Polubenská 614 / 468 61 Desná / Czech Republic
T +420 271 961 170 / www.eye2000.cz / info@eye2000.cz



atelier
kreativ

CAROL

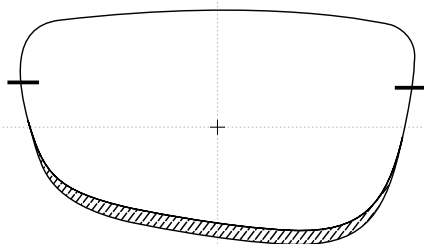

0,5 mm

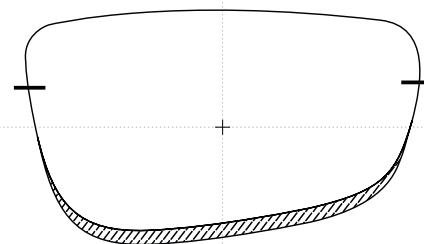

CEZAR

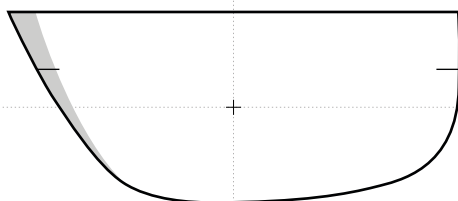

0 mm

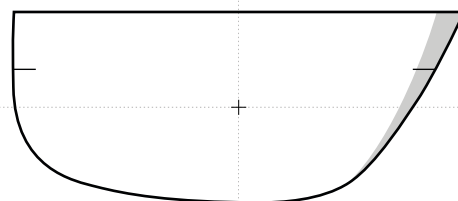

CLAUDIA

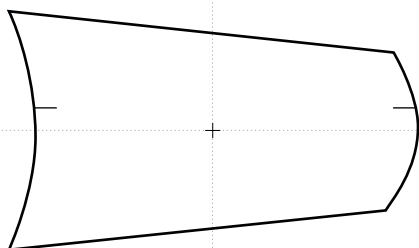

0,5 mm

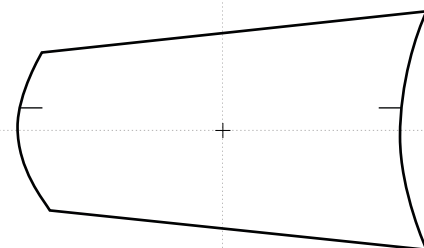

CTIBOR

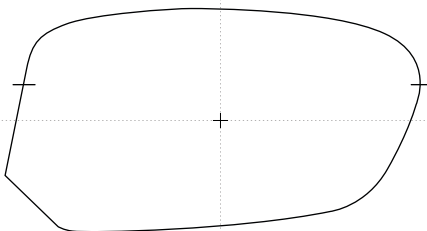

0 mm

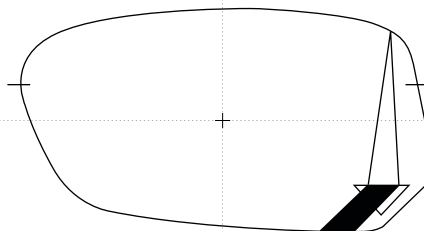

Tyto kreativní tvary brýlových čoček byly navrženy a vyrobeny v ateliéru kreativ při společnosti EYE 2000 s.r.o. a jsou chráněny Úřadem průmyslového vlastnictví jako průmyslový vzor.
These creative glasses lens shapes were designed and produced by atelier kreativ by EYE 2000 s.r.o. company and are patented and protected by the Authority of the Industrial Property.

EYE 2000 s.r.o. / Ohmova 271 / 109 00 Praha 10 / Czech Republic / Provozovna / Polubenská 614 / 468 61 Desná / Czech Republic
T +420 271 961 170 / www.eye2000.cz / info@eye2000.cz



ateliér
kreativ

CUPRIA

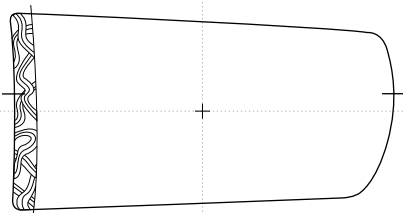

0 mm

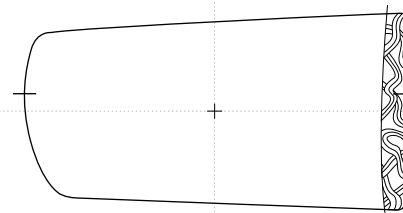

CYNTIE

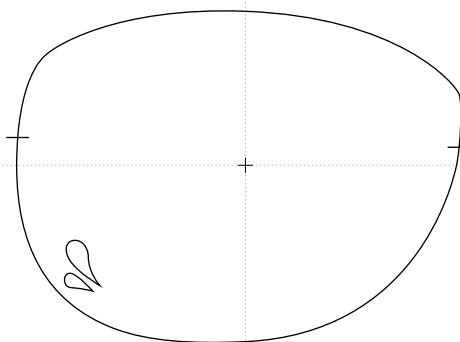

0 mm

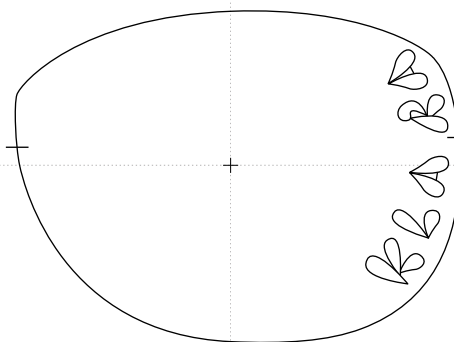

DAGMAR

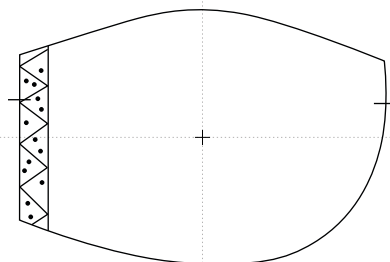

0 mm

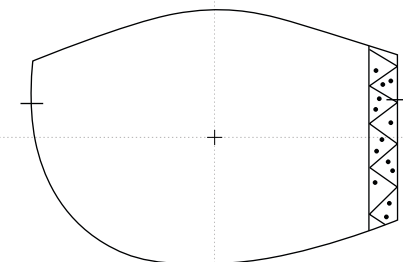

DANICA

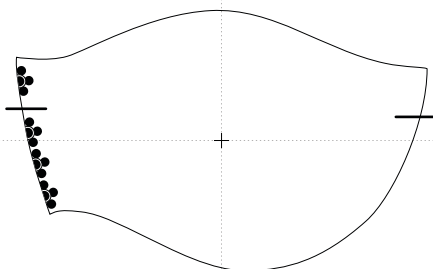

1 mm

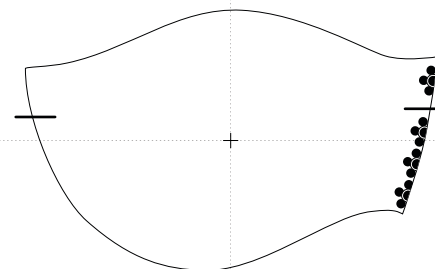

Tyto kreativní tvary brýlových čoček byly navrženy a vyrobeny v ateliéru kreativ při společnosti EYE 2000 s.r.o. a jsou chráněny Úřadem průmyslového vlastnictví jako průmyslový vzor. These creative glasses lens shapes were designed and produced by ateliér kreativ by EYE 2000 s.r.o. company and are patented and protected by the Authority of the Industrial Property.

EYE 2000 s.r.o. / Ohmova 271 / 109 00 Praha 10 / Czech Republic / Provozovna / Polubenská 614 / 468 61 Desná / Czech Republic
T +420 271 961 170 / www.eye2000.cz / info@eye2000.cz



atelier
kreativ

DAPHNE

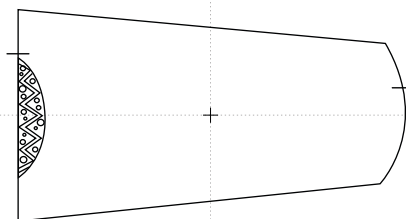

0,5 mm

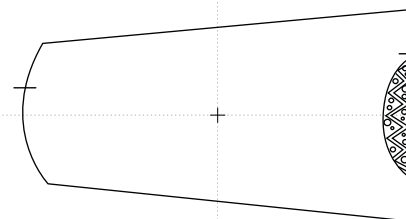

DARA

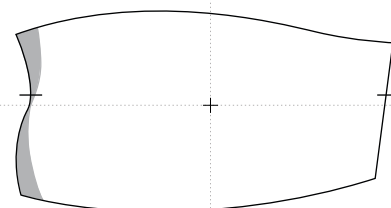

1 mm

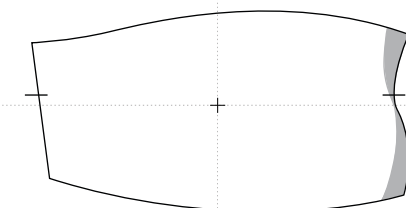

DARINA

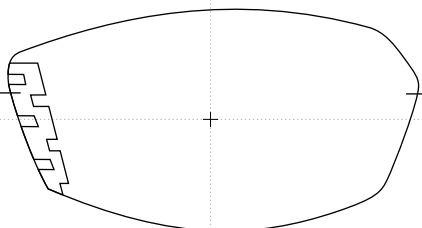

0 mm

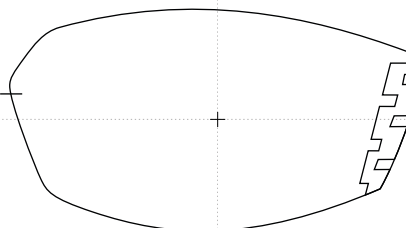

DARJA

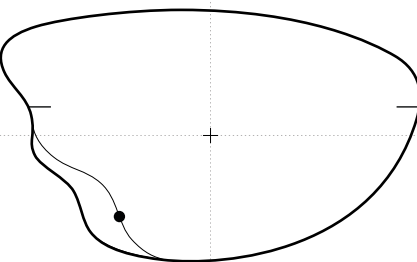

0 mm

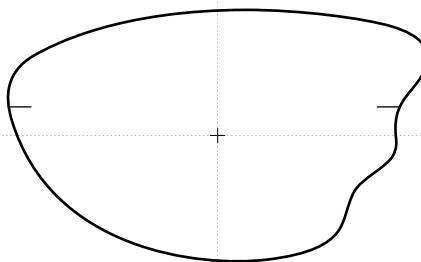

Tyto kreativní tvary brýlových čoček byly navrženy a vyrobeny v ateliéru kreativ při společnosti EYE 2000 s.r.o. a jsou chráněny Úřadem průmyslového vlastnictví jako průmyslový vzor. These creative glasses lens shapes were designed and produced by atelier kreativ by EYE 2000 s.r.o. company and are patented and protected by the Authority of the Industrial Property.

EYE 2000 s.r.o. / Ohmova 271 / 109 00 Praha 10 / Czech Republic / Provozovna / Polubenská 614 / 468 61 Desná / Czech Republic
T +420 271 961 170 / www.eye2000.cz / info@eye2000.cz



ateliér
kreativ

DAVID

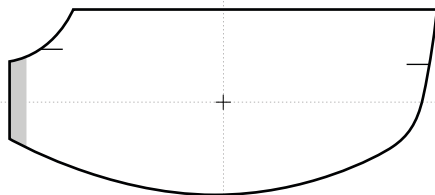

1 mm

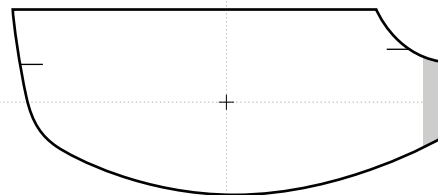

DEBORA

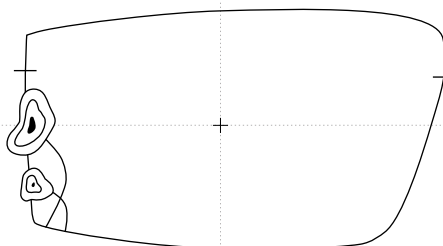

0,5 mm

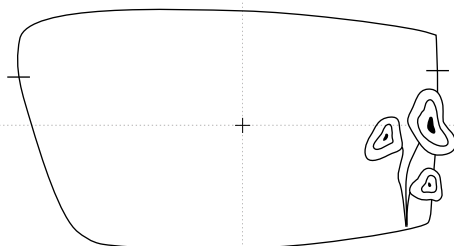

DENISA

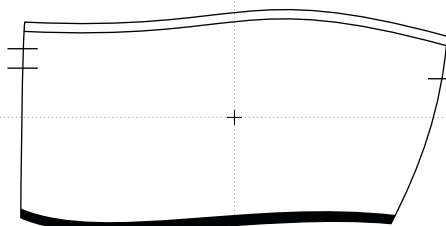

0,5 mm

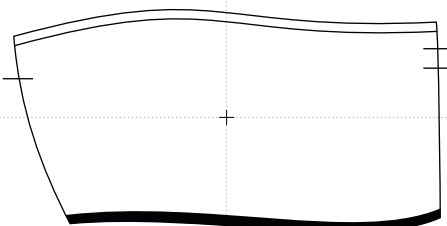

DIANA

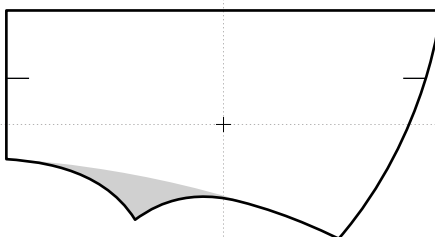

2 mm

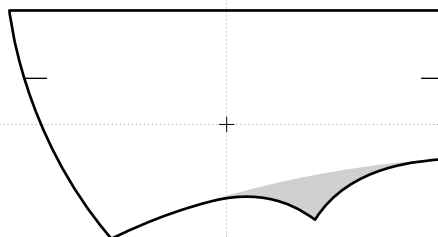

Tyto kreativní tvary brýlových čoček byly navrženy a vyrobeny v ateliéru kreativ při společnosti EYE 2000 s.r.o. a jsou chráněny Úřadem průmyslového vlastnictví jako průmyslový vzor.
These creative glasses lens shapes were designed and produced by ateliér kreativ by EYE 2000 s.r.o. company and are patented and protected by the Authority of the Industrial Property.

EYE 2000 s.r.o. / Ohmova 271 / 109 00 Praha 10 / Czech Republic / Provozovna / Polubenská 614 / 468 61 Desná / Czech Republic
T +420 271 961 170 / www.eye2000.cz / info@eye2000.cz



ateliér
kreativ

DITA

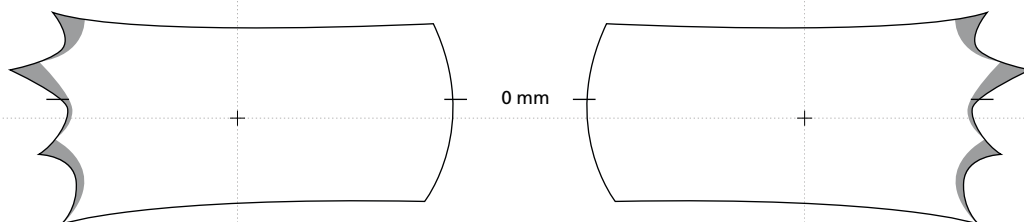

DOBRUSKA

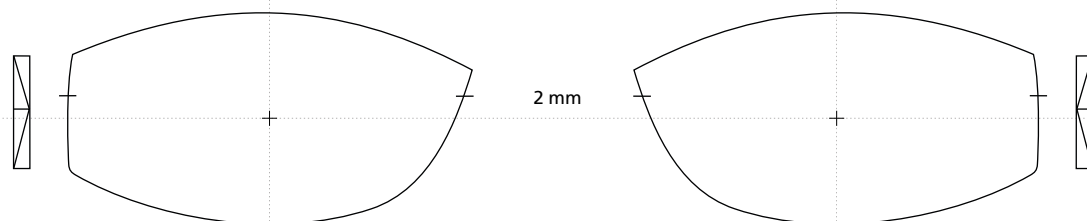

DOMINIKA

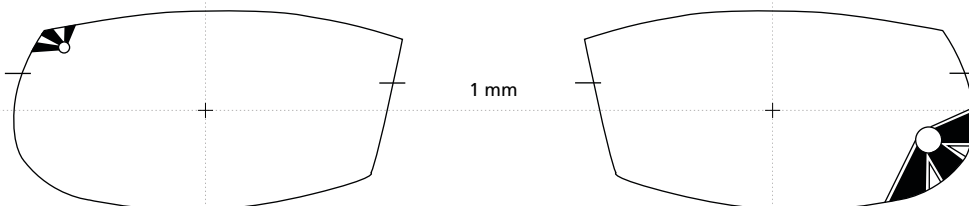

DOROTKA

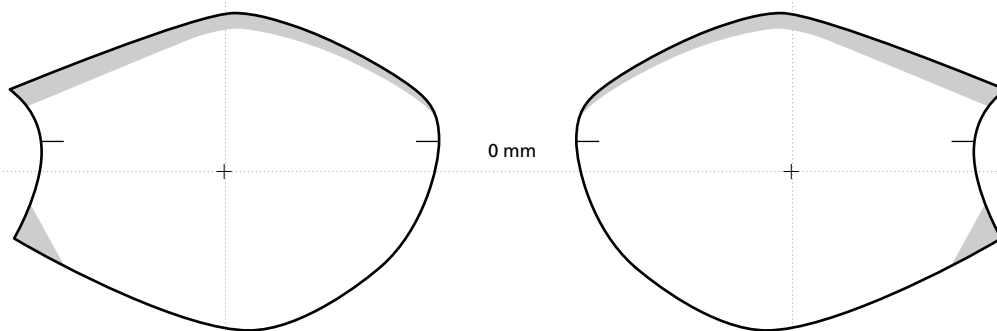

Tyto kreativní tvary brýlových čoček byly navrženy a vyrobeny v ateliéru kreativ při společnosti EYE 2000 s.r.o. a jsou chráněny Úřadem průmyslového vlastnictví jako průmyslový vzor. These creative glasses lens shapes were designed and produced by ateliér kreativ by EYE 2000 s.r.o. company and are patented and protected by the Authority of the Industrial Property.

EYE 2000 s.r.o. / Ohmova 271 / 109 00 Praha 10 / Czech Republic / Provozovna / Polubenská 614 / 468 61 Desná / Czech Republic
T +420 271 961 170 / www.eyeye2000.cz / info@eyeye2000.cz



ateliér
kreativ

DRAGANA

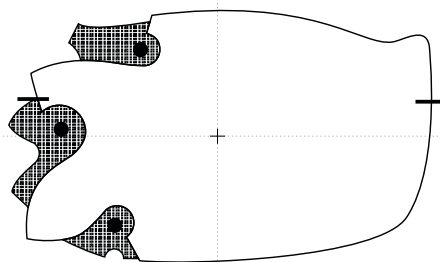

0 mm

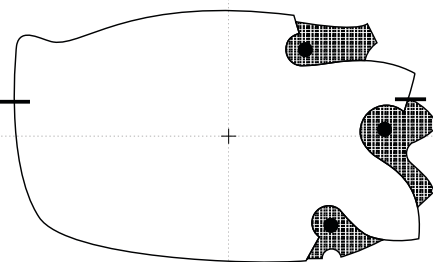

DRAHA

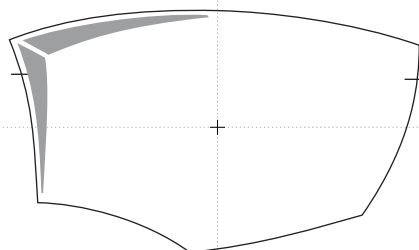

0,25 mm

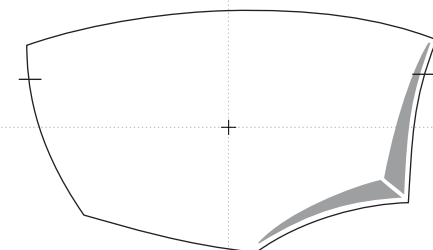

EDITA

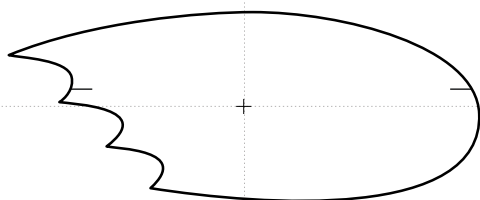

1 mm

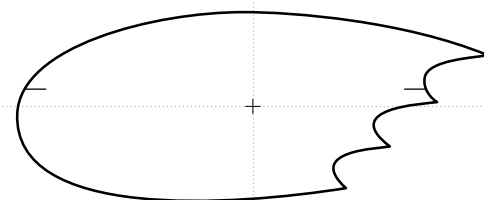

ELEKTRA

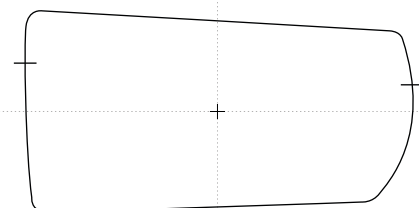

0,5 mm

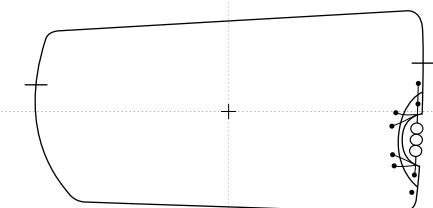

Tyto kreativní tvary brýlových čoček byly navrženy a vyrobeny v ateliéru kreativ při společnosti EYE 2000 s.r.o. a jsou chráněny Úřadem průmyslového vlastnictví jako průmyslový vzor.
These creative glasses lens shapes were designed and produced by ateliér kreativ by EYE 2000 s.r.o. company and are patented and protected by the Authority of the Industrial Property.

EYE 2000 s.r.o. / Ohmova 271 / 109 00 Praha 10 / Czech Republic / Provozovna / Polubenská 614 / 468 61 Desná / Czech Republic
T +420 271 961 170 / www.eye2000.cz / info@eye2000.cz



atelier
kreativ

ELENA

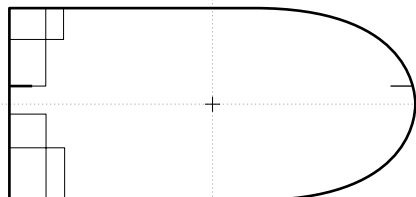

1 mm

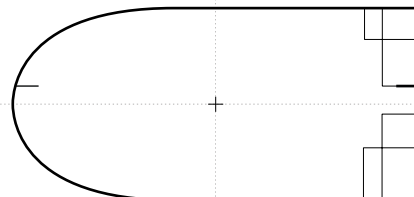

ELISKA

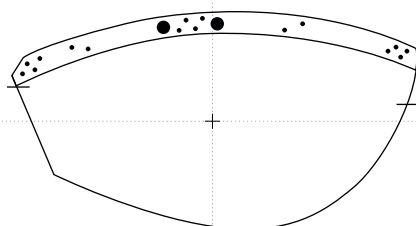

1,4 mm

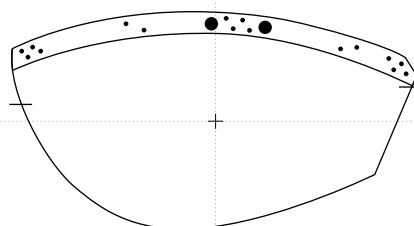

EMANUELA

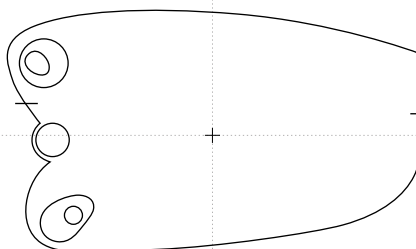

0 mm

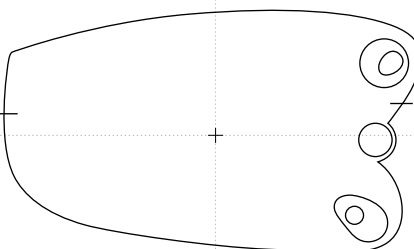

ERBIA

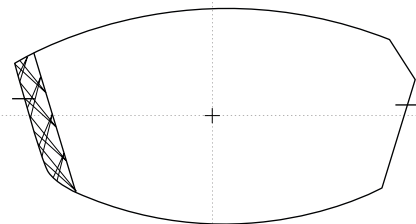

1 mm

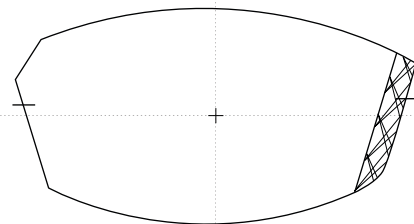

Tyto kreativní tvary brýlových čoček byly navrženy a vyrobeny v ateliéru kreativ při společnosti EYE 2000 s.r.o. a jsou chráněny Úřadem průmyslového vlastnictví jako průmyslový vzor.
These creative glasses lens shapes were designed and produced by atelier kreativ by EYE 2000 s.r.o. company and are patented and protected by the Authority of the Industrial Property.

EYE 2000 s.r.o. / Ohmova 271 / 109 00 Praha 10 / Czech Republic / Provozovna / Polubenská 614 / 468 61 Desná / Czech Republic
T +420 271 961 170 / www.eye2000.cz / info@eye2000.cz



ateliér
kreativ

ERIKA

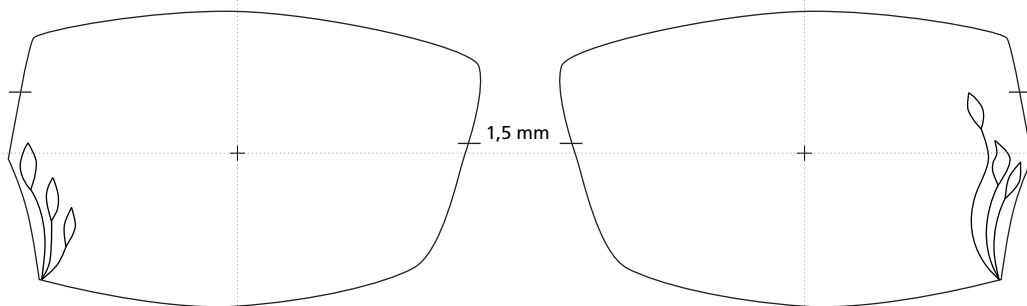

ESET

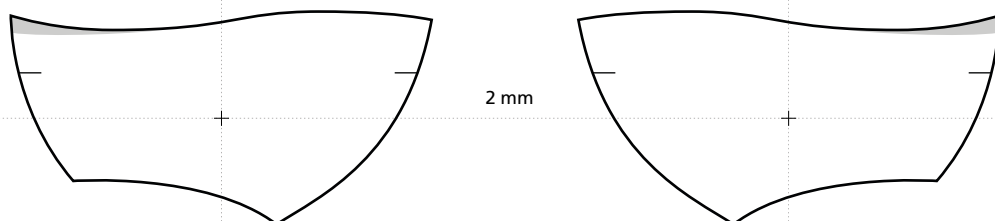

ESTELA

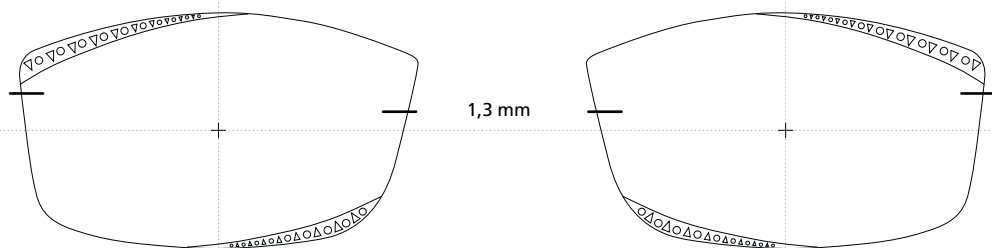

ESTER

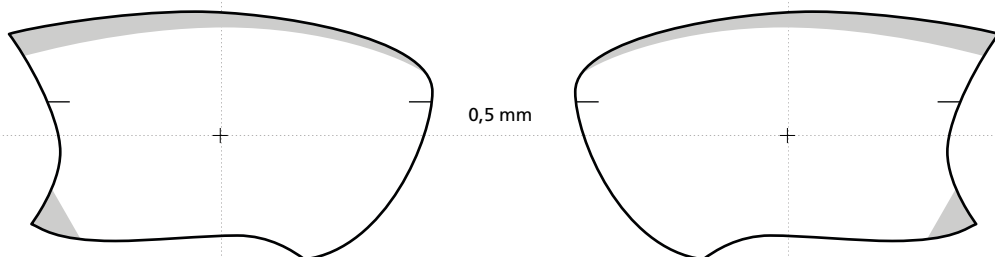

Tyto kreativní tvary brýlových čoček byly navrženy a vyrobeny v ateliéru kreativ při společnosti EYE 2000 s.r.o. a jsou chráněny Úřadem průmyslového vlastnictví jako průmyslový vzor. These creative glasses lens shapes were designed and produced by ateliér kreativ by EYE 2000 s.r.o. company and are patented and protected by the Authority of the Industrial Property.

EYE 2000 s.r.o. / Ohmova 271 / 109 00 Praha 10 / Czech Republic / Provozovna / Polubenská 614 / 468 61 Desná / Czech Republic
T +420 271 961 170 / www.eyeye2000.cz / info@eyeye2000.cz



ateliér
kreativ

EUFROZINIE

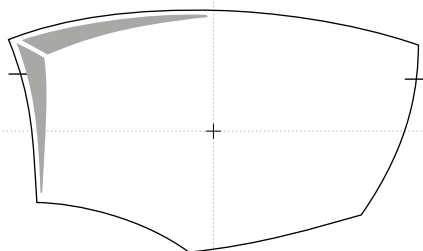

0 mm

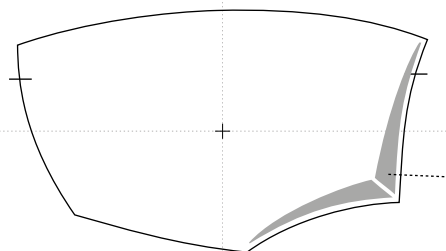

EVA

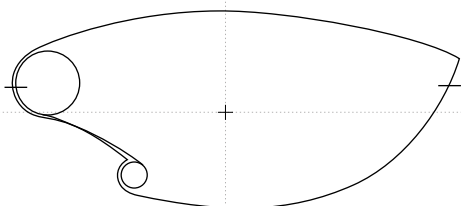

1 mm

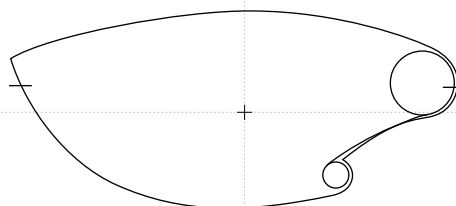

EVELINA

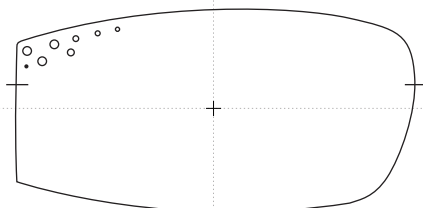

0 mm

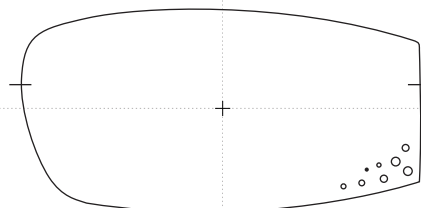

EVZENIE

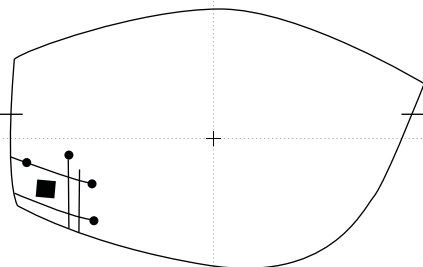

2 mm

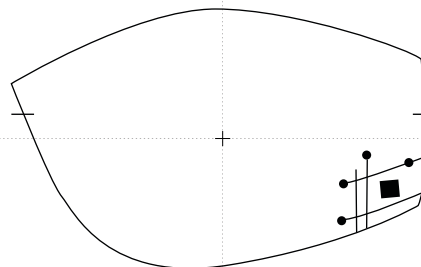

Tyto kreativní tvary brýlových čoček byly navrženy a vyrobeny v ateliéru kreativ při společnosti EYE 2000 s.r.o. a jsou chráněny Úřadem průmyslového vlastnictví jako průmyslový vzor. These creative glasses lens shapes were designed and produced by ateliér kreativ by EYE 2000 s.r.o. company and are patented and protected by the Authority of the Industrial Property.

EYE 2000 s.r.o. / Ohmova 271 / 109 00 Praha 10 / Czech Republic / Provozovna / Polubenská 614 / 468 61 Desná / Czech Republic
T +420 271 961 170 / www.eye2000.cz / info@eye2000.cz



ateliér
kreativ

F1008

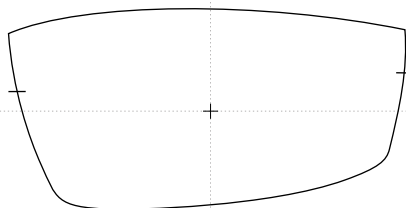

0,5 mm

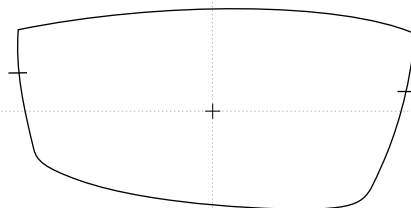

F861+3

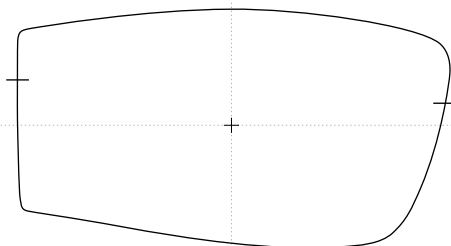

0,5 mm

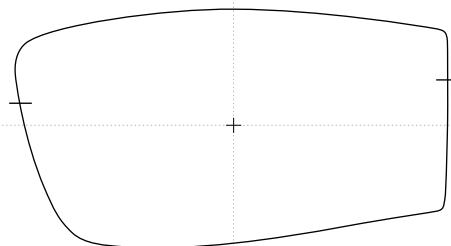

FANYNKA

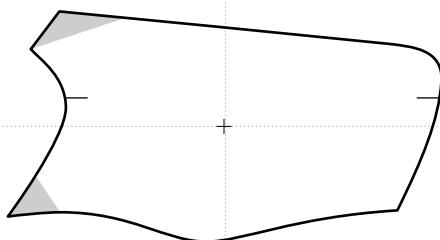

0,5 mm

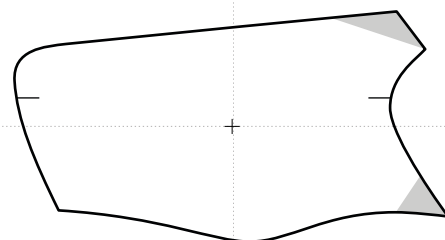

FARIS

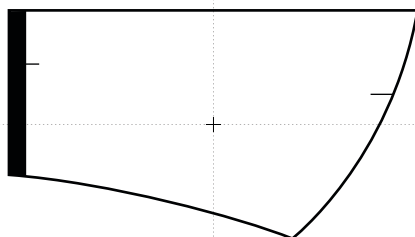

3 mm

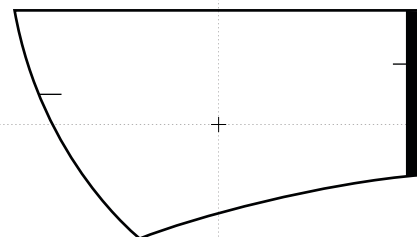

Tyto kreativní tvary brýlových čoček byly navrženy a vyrobeny v ateliéru kreativ při společnosti EYE 2000 s.r.o. a jsou chráněny Úřadem průmyslového vlastnictví jako průmyslový vzor.
These creative glasses lens shapes were designed and produced by ateliér kreativ by EYE 2000 s.r.o. company and are patented and protected by the Authority of the Industrial Property.

EYE 2000 s.r.o. / Ohmova 271 / 109 00 Praha 10 / Czech Republic / Provozovna / Polubenská 614 / 468 61 Desná / Czech Republic
T +420 271 961 170 / www.eye2000.cz / info@eye2000.cz



FEDERICO

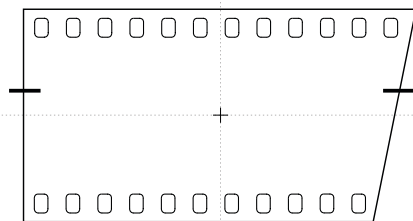

2,3 mm

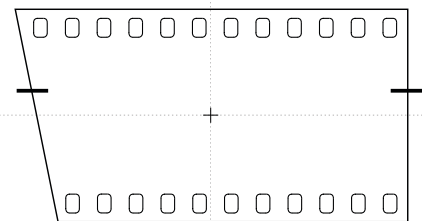

FERARA

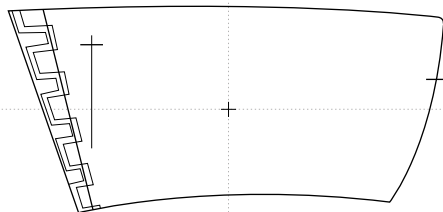

1 mm

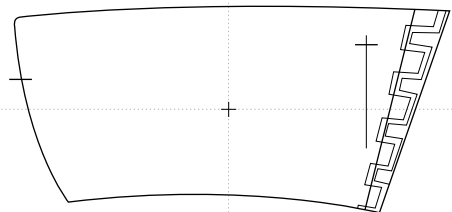

FERDA

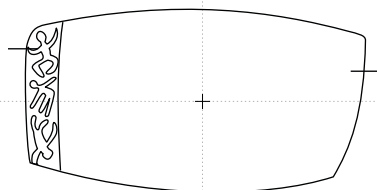

0 mm

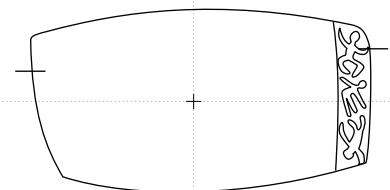

FERGIE

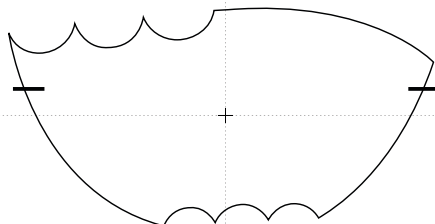

1,5 mm

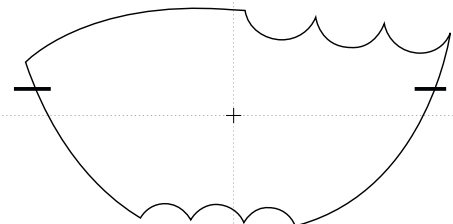

Tyto kreativní tvary brýlových čoček byly navrženy a vyrobeny v ateliéru kreativ při společnosti EYE 2000 s.r.o. a jsou chráněny Úřadem průmyslového vlastnictví jako průmyslový vzor. These creative glasses lens shapes were designed and produced by ateliér kreativ by EYE 2000 s.r.o. company and are patented and protected by the Authority of the Industrial Property.

EYE 2000 s.r.o. / Ohmova 271 / 109 00 Praha 10 / Czech Republic / Provozovna / Polubenská 614 / 468 61 Desná / Czech Republic
T +420 271 961 170 / www.eye2000.cz / info@eye2000.cz



ateliér
kreativ

FERRON

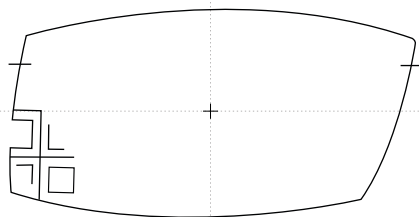

0,5 mm

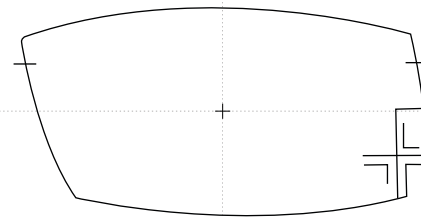

FIALKA

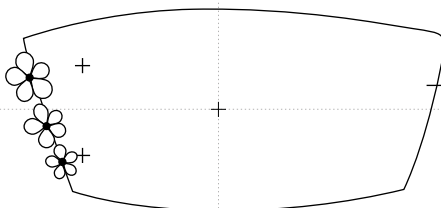

0,5 mm

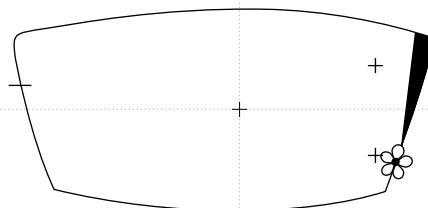

FILIP

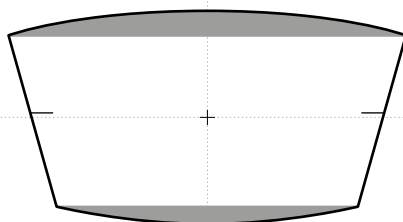

3 mm

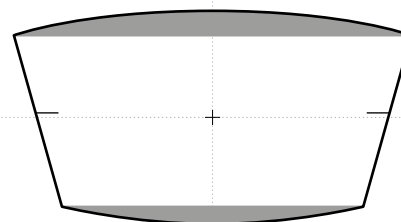

FIONA

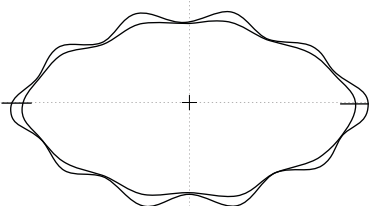

0 mm

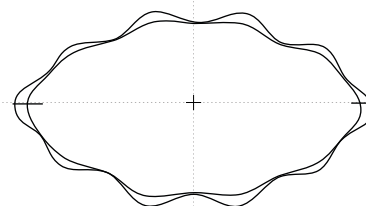

Tyto kreativní tvary brýlových čoček byly navrženy a vyrobeny v ateliéru kreativ při společnosti EYE 2000 s.r.o. a jsou chráněny Úřadem průmyslového vlastnictví jako průmyslový vzor. These creative glasses lens shapes were designed and produced by ateliér kreativ by EYE 2000 s.r.o. company and are patented and protected by the Authority of the Industrial Property.

EYE 2000 s.r.o. / Ohmova 271 / 109 00 Praha 10 / Czech Republic / Provozovna / Polubenská 614 / 468 61 Desná / Czech Republic
T +420 271 961 170 / www.eye2000.cz / info@eye2000.cz



ateliér
kreativ

FLAVIE

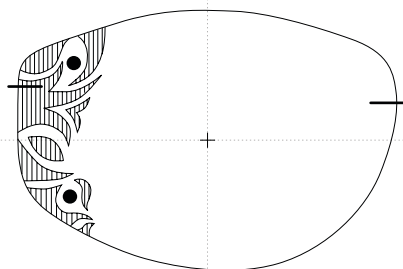

0 mm

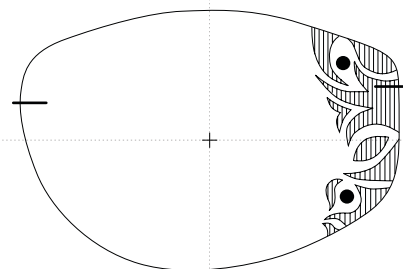

FLUORA

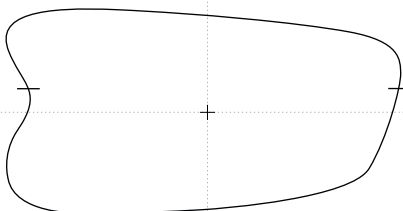

0,5 mm

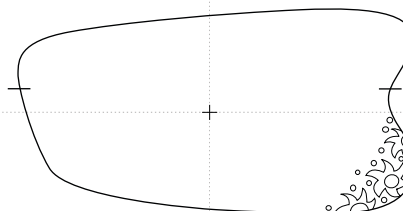

GABRIELA

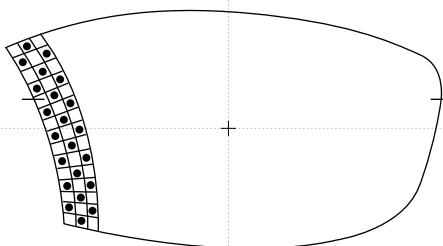

0 mm

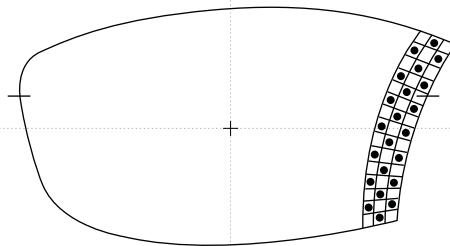

GALLA

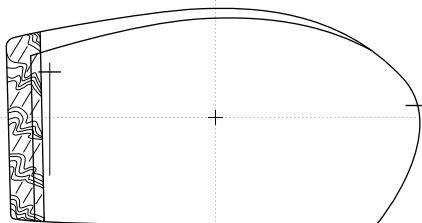

0 mm

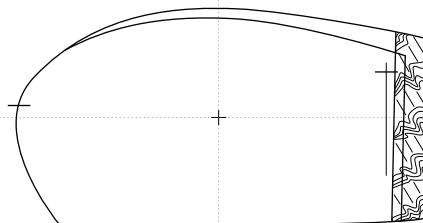

Tyto kreativní tvary brýlových čoček byly navrženy a vyrobeny v ateliéru kreativ při společnosti EYE 2000 s.r.o. a jsou chráněny Úřadem průmyslového vlastnictví jako průmyslový vzor.
These creative glasses lens shapes were designed and produced by ateliér kreativ by EYE 2000 s.r.o. company and are patented and protected by the Authority of the Industrial Property.

EYE 2000 s.r.o. / Ohmova 271 / 109 00 Praha 10 / Czech Republic / Provozovna / Polubenská 614 / 468 61 Desná / Czech Republic
T +420 271 961 170 / www.eye2000.cz / info@eye2000.cz



ateliér
kreativ

GERALDINA

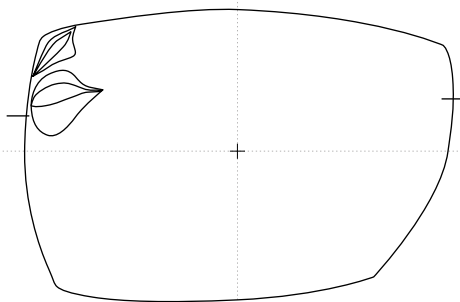

0 mm

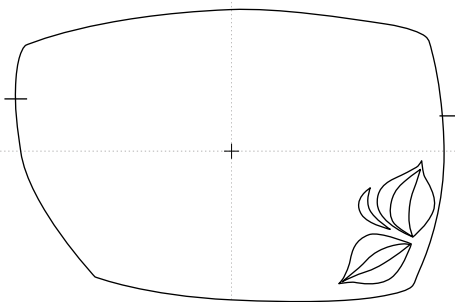

GILBERT

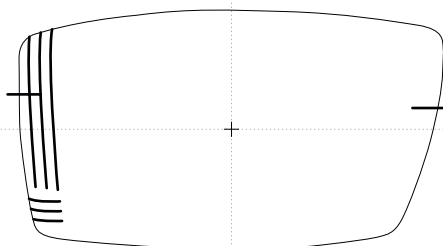

0,7 mm

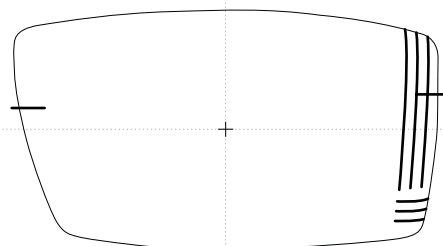

GITA

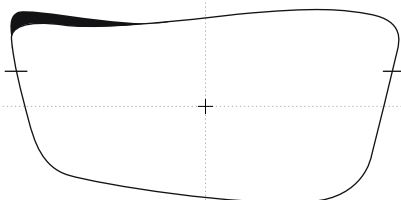

1 mm

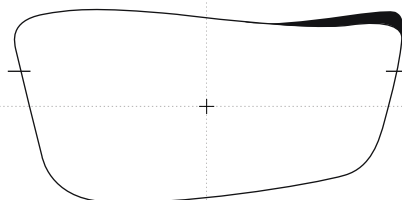

GIZELA

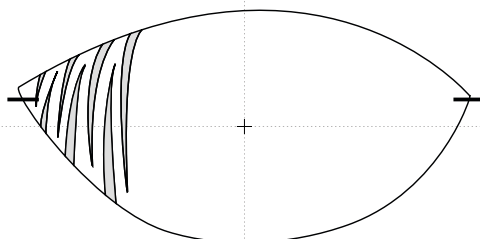

0 mm

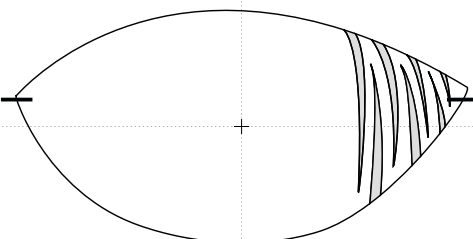

Tyto kreativní tvary brýlových čoček byly navrženy a vyrobeny v ateliéru kreativ při společnosti EYE 2000 s.r.o. a jsou chráněny Úřadem průmyslového vlastnictví jako průmyslový vzor. These creative glasses lens shapes were designed and produced by ateliér kreativ by EYE 2000 s.r.o. company and are patented and protected by the Authority of the Industrial Property.

EYE 2000 s.r.o. / Ohmova 271 / 109 00 Praha 10 / Czech Republic / Provozovna / Polubenská 614 / 468 61 Desná / Czech Republic
T +420 271 961 170 / www.eye2000.cz / info@eye2000.cz



atelier
kreativ

GRACIE

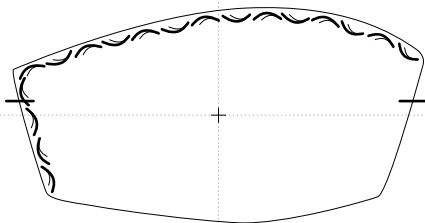

1,4 mm

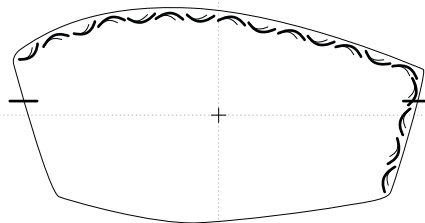

GREGOR

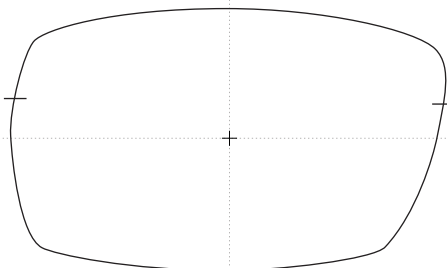

0,5 mm

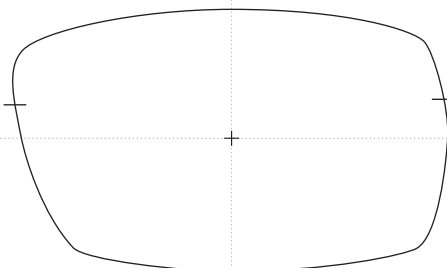

HANA

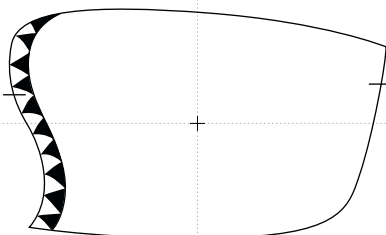

0,6 mm

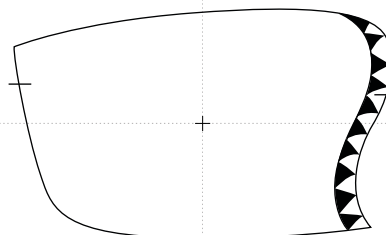

HANALORE

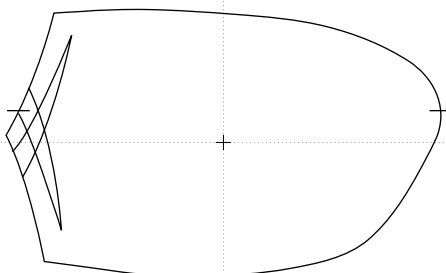

0 mm

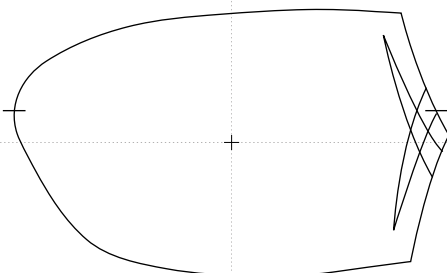

Tyto kreativní tvary brýlových čoček byly navrženy a vyrobeny v ateliéru kreativ při společnosti EYE 2000 s.r.o. a jsou chráněny Úřadem průmyslového vlastnictví jako průmyslový vzor.
These creative glasses lens shapes were designed and produced by atelier kreativ by EYE 2000 s.r.o. company and are patented and protected by the Authority of the Industrial Property.

EYE 2000 s.r.o. / Ohmova 271 / 109 00 Praha 10 / Czech Republic / Provozovna / Polubenská 614 / 468 61 Desná / Czech Republic
T +420 271 961 170 / www.eyeye2000.cz / info@eyeye2000.cz



atelier
kreativ

HASSI

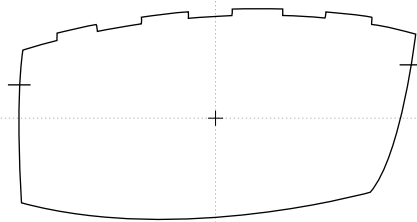

0,5 mm

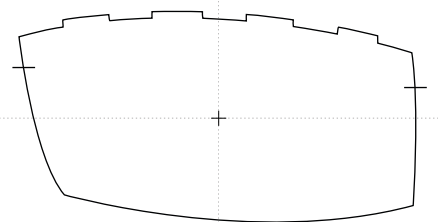

HEDVIKA

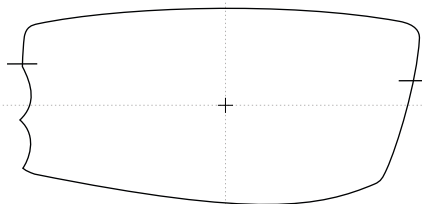

1 mm

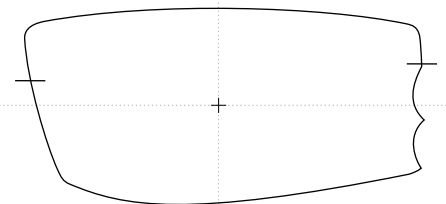

HELENKA

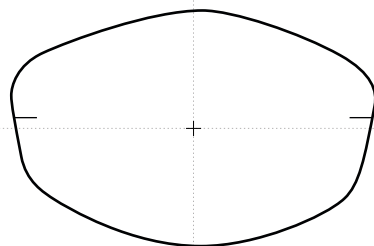

0,5 mm

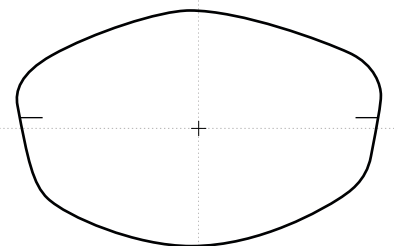

HELIA

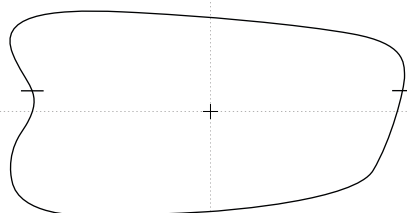

0,5 mm

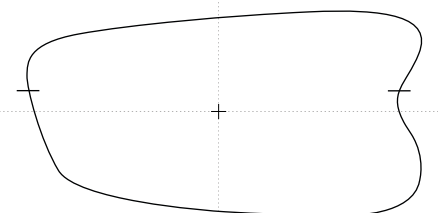

Tyto kreativní tvary brýlových čoček byly navrženy a vyrobeny v ateliéru kreativ při společnosti EYE 2000 s.r.o. a jsou chráněny Úřadem průmyslového vlastnictví jako průmyslový vzor.
These creative glasses lens shapes were designed and produced by atelier kreativ by EYE 2000 s.r.o. company and are patented and protected by the Authority of the Industrial Property.

EYE 2000 s.r.o. / Ohmova 271 / 109 00 Praha 10 / Czech Republic / Provozovna / Polubenská 614 / 468 61 Desná / Czech Republic
T +420 271 961 170 / www.eye2000.cz / info@eye2000.cz



ateliér
kreativ

HERBERT

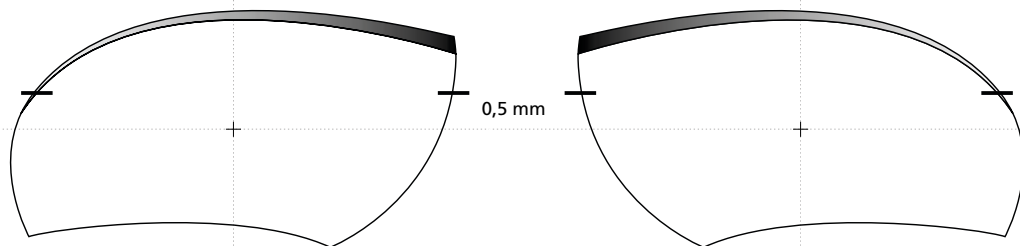

HERMINA

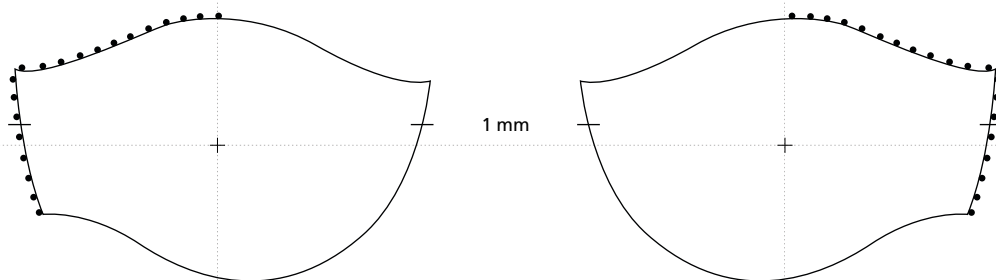

HORTENSIE

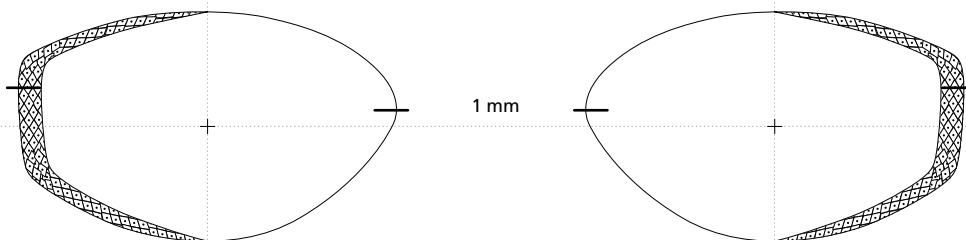

HUBERT

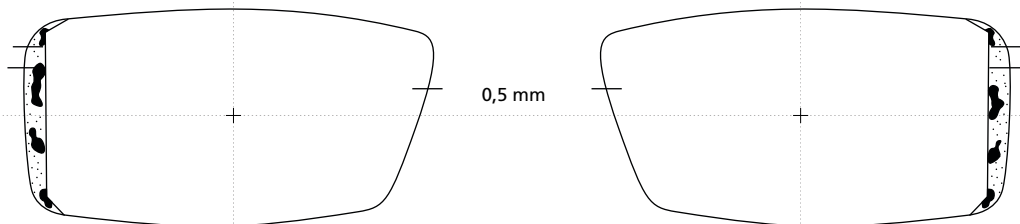

Tyto kreativní tvary brýlových čoček byly navrženy a vyrobeny v ateliéru kreativ při společnosti EYE 2000 s.r.o. a jsou chráněny Úřadem průmyslového vlastnictví jako průmyslový vzor.
These creative glasses lens shapes were designed and produced by ateliér kreativ by EYE 2000 s.r.o. company and are patented and protected by the Authority of the Industrial Property.

EYE 2000 s.r.o. / Ohmova 271 / 109 00 Praha 10 / Czech Republic / Provozovna / Polubenská 614 / 468 61 Desná / Czech Republic
T +420 271 961 170 / www.eye2000.cz / info@eye2000.cz



HYDRIA

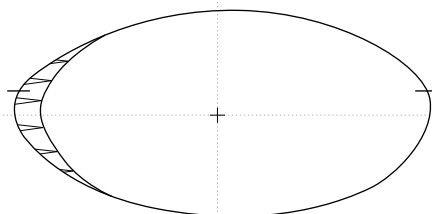

0,5 mm

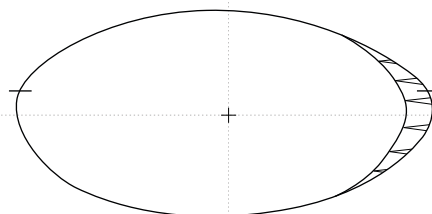

HYNEK

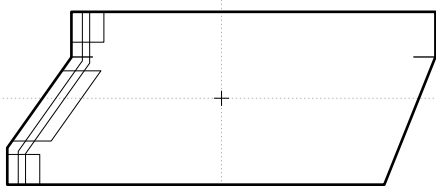

0 mm

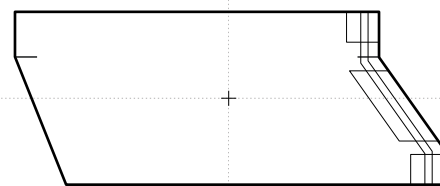

CHARLIE

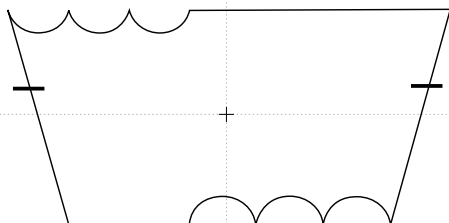

3,1 mm

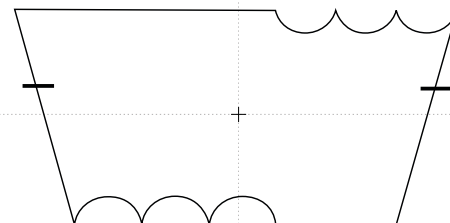

IDA

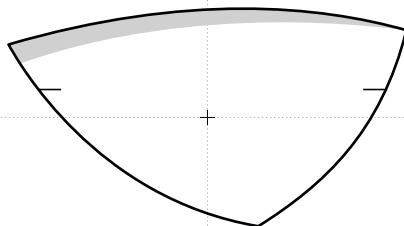

3 mm

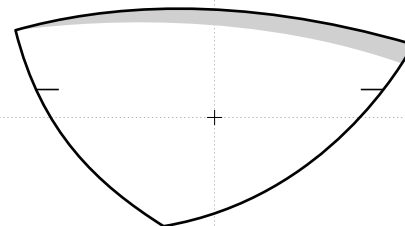

Tyto kreativní tvary brýlových čoček byly navrženy a vyrobeny v ateliéru kreativ při společnosti EYE 2000 s.r.o. a jsou chráněny Úřadem průmyslového vlastnictví jako průmyslový vzor.
These creative glasses lens shapes were designed and produced by ateliér kreativ by EYE 2000 s.r.o. company and are patented and protected by the Authority of the Industrial Property.

EYE 2000 s.r.o. / Ohmova 271 / 109 00 Praha 10 / Czech Republic / Provozovna / Polubenská 614 / 468 61 Desná / Czech Republic
T +420 271 961 170 / www.eyeye2000.cz / info@eyeye2000.cz



ateliér
kreativ

INGRID

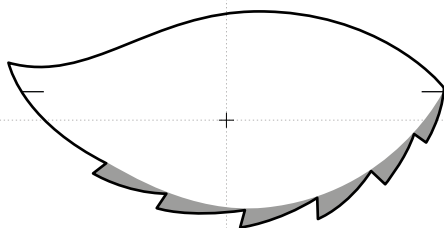

0 mm

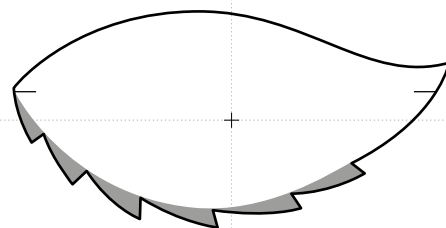

IRENA

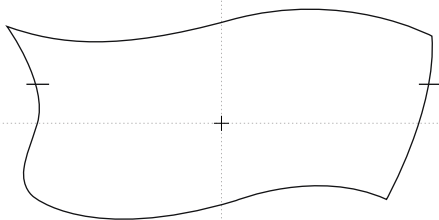

0,5 mm

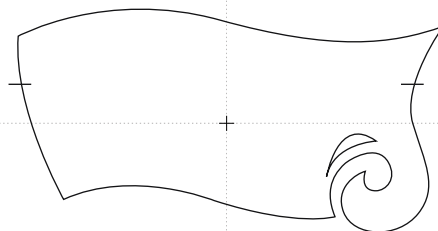

IRIDIA

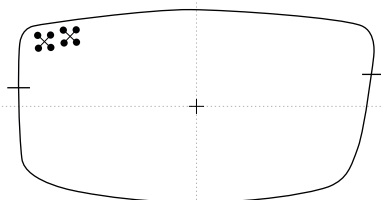

0,5 mm

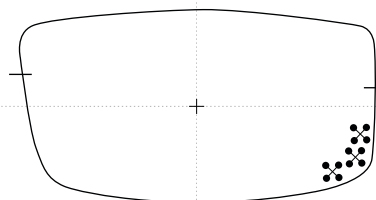

IRMA

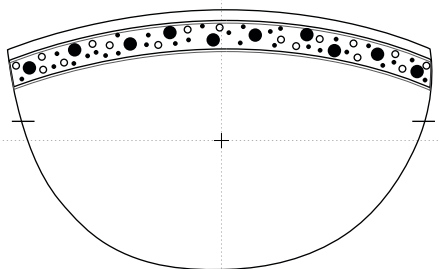

1 mm

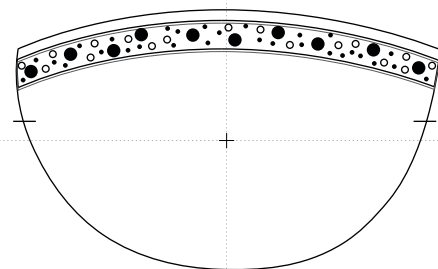

Tyto kreativní tvary brýlových čoček byly navrženy a vyrobeny v ateliéru kreativ při společnosti EYE 2000 s.r.o. a jsou chráněny Úřadem průmyslového vlastnictví jako průmyslový vzor. These creative glasses lens shapes were designed and produced by ateliér kreativ by EYE 2000 s.r.o. company and are patented and protected by the Authority of the Industrial Property.

EYE 2000 s.r.o. / Ohmova 271 / 109 00 Praha 10 / Czech Republic / Provozovna / Polubenská 614 / 468 61 Desná / Czech Republic
T +420 271 961 170 / www.eye2000.cz / info@eye2000.cz



atelier
kreativ

ISABELA

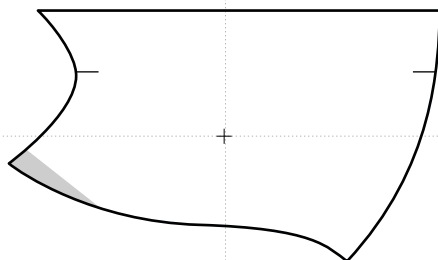

0,5 mm

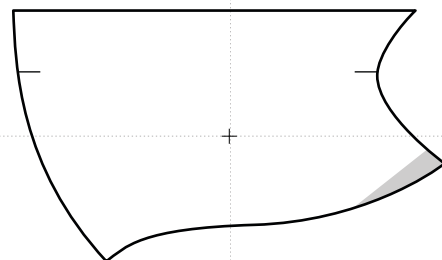

ISIS

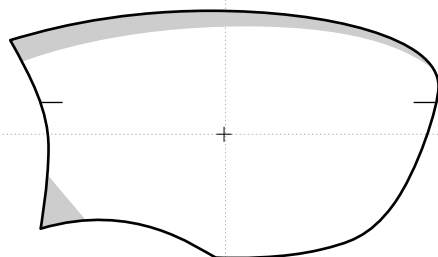

0,5 mm

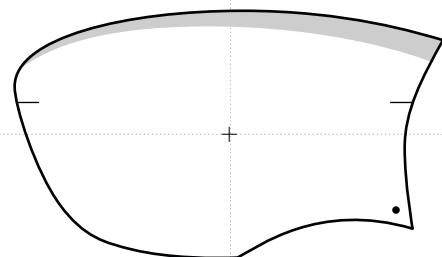

IVANKA

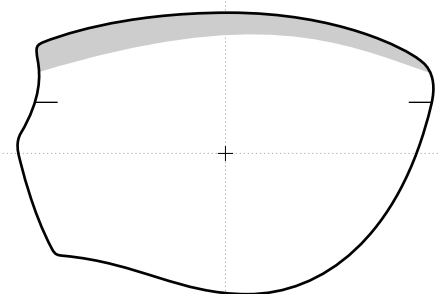

0,5 mm

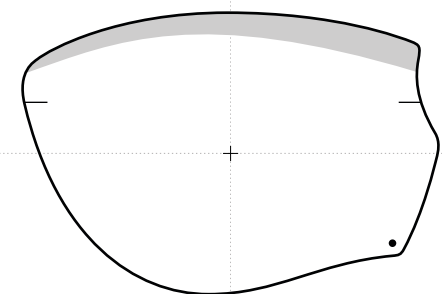

IVETA

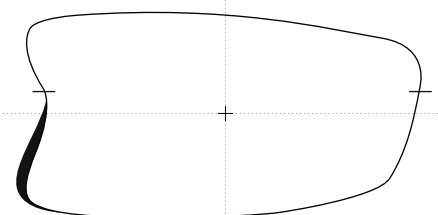

0 mm

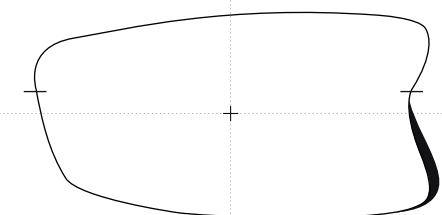

Tyto kreativní tvary brýlových čoček byly navrženy a vyrobeny v ateliéru kreativ při společnosti EYE 2000 s.r.o. a jsou chráněny Úřadem průmyslového vlastnictví jako průmyslový vzor.
These creative glasses lens shapes were designed and produced by atelier kreativ by EYE 2000 s.r.o. company and are patented and protected by the Authority of the Industrial Property.

EYE 2000 s.r.o. / Ohmova 271 / 109 00 Praha 10 / Czech Republic / Provozovna / Polubenská 614 / 468 61 Desná / Czech Republic
T +420 271 961 170 / www.eye2000.cz / info@eye2000.cz



ateliér
kreativ

IVONA

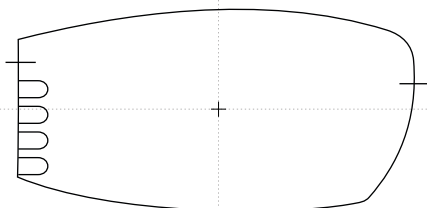

0 mm

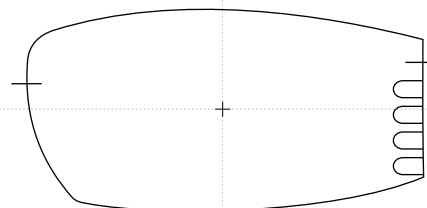

IZIDORA

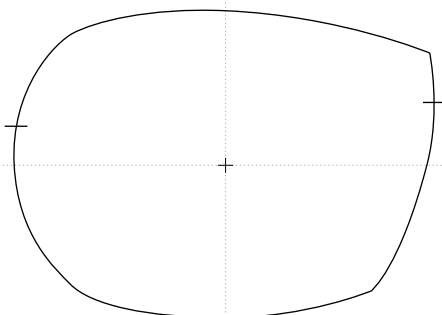

0 mm

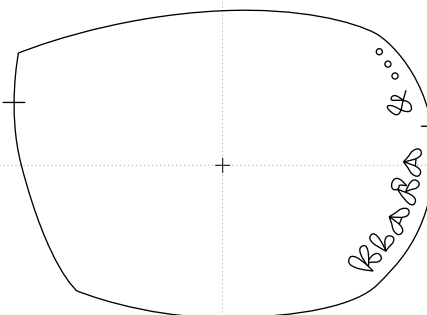

JACKIE

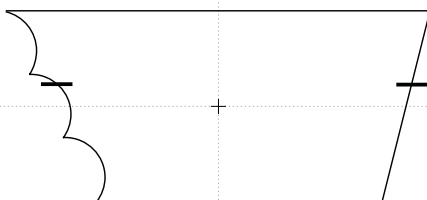

2,4 mm

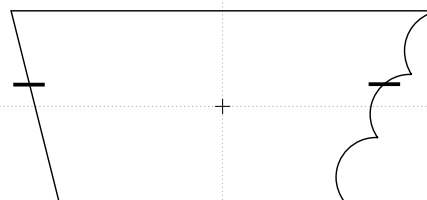

JAN

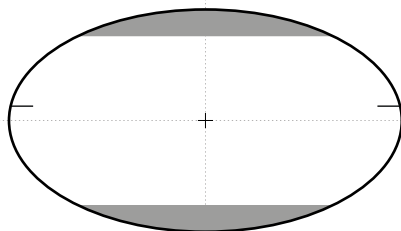

0,5 mm

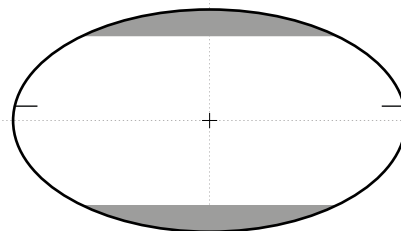

Tyto kreativní tvary brýlových čoček byly navrženy a vyrobeny v ateliéru kreativ při společnosti EYE 2000 s.r.o. a jsou chráněny Úřadem průmyslového vlastnictví jako průmyslový vzor. These creative glasses lens shapes were designed and produced by ateliér kreativ by EYE 2000 s.r.o. company and are patented and protected by the Authority of the Industrial Property.

EYE 2000 s.r.o. / Ohmova 271 / 109 00 Praha 10 / Czech Republic / Provozovna / Polubenská 614 / 468 61 Desná / Czech Republic
T +420 271 961 170 / www.eyeye2000.cz / info@eyeye2000.cz



ateliér
kreativ

JARKA

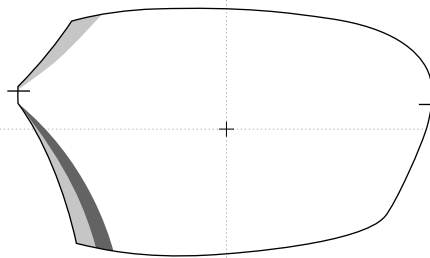

0,25 mm

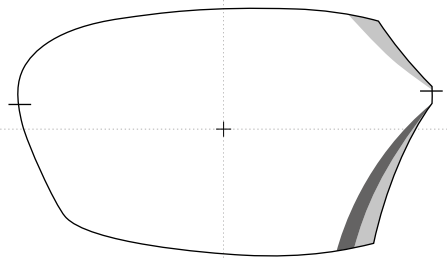

JASNENKA

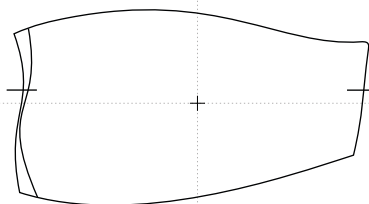

0,5 mm

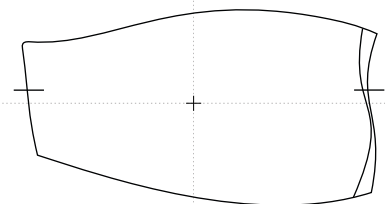

JING-JANG

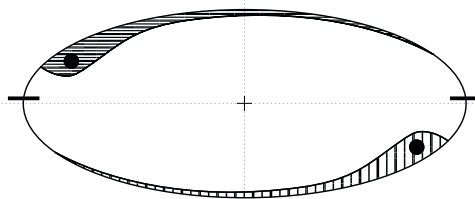

0 mm

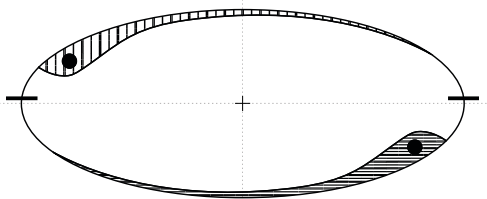

JIRINA

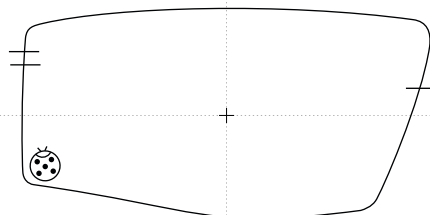

1,5 mm

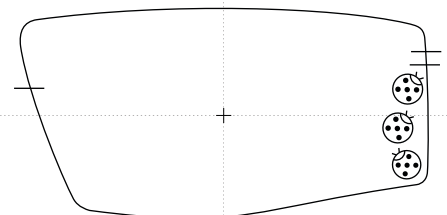

Tyto kreativní tvary brýlových čoček byly navrženy a vyrobeny v ateliéru kreativ při společnosti EYE 2000 s.r.o. a jsou chráněny Úřadem průmyslového vlastnictví jako průmyslový vzor.
These creative glasses lens shapes were designed and produced by ateliér kreativ by EYE 2000 s.r.o. company and are patented and protected by the Authority of the Industrial Property.

EYE 2000 s.r.o. / Ohmova 271 / 109 00 Praha 10 / Czech Republic / Provozovna / Polubenská 614 / 468 61 Desná / Czech Republic
T +420 271 961 170 / www.eyeye2000.cz / info@eyeye2000.cz



ateliér
kreativ

JITKA

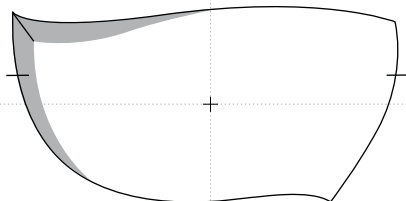

0,5 mm

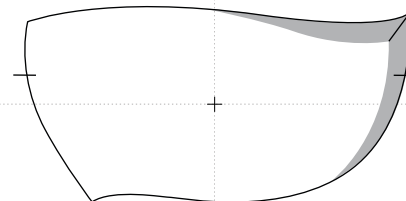

JITRENKA

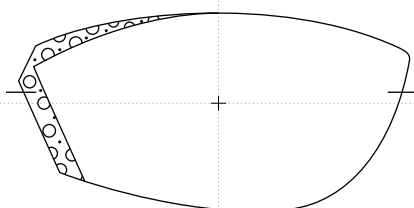

1 mm

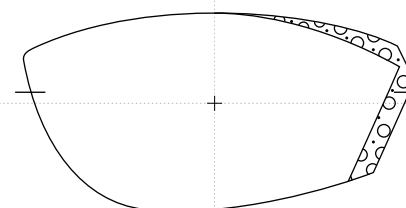

JOHANKA

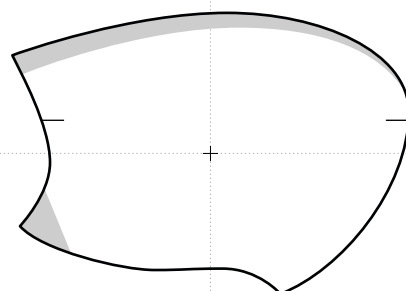

0 mm

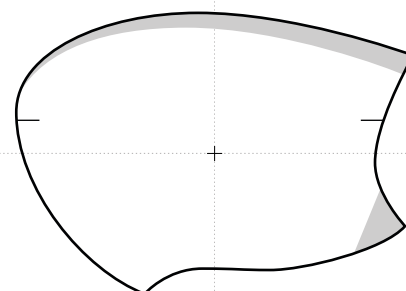

JOLANKA

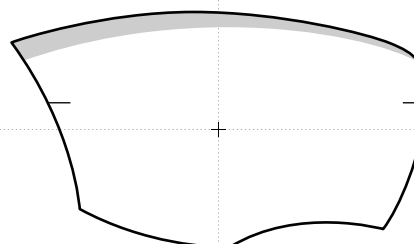

0 mm

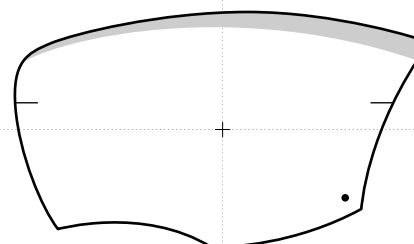

Tyto kreativní tvary brýlových čoček byly navrženy a vyrobeny v ateliéru kreativ při společnosti EYE 2000 s.r.o. a jsou chráněny Úřadem průmyslového vlastnictví jako průmyslový vzor.
These creative glasses lens shapes were designed and produced by ateliér kreativ by EYE 2000 s.r.o. company and are patented and protected by the Authority of the Industrial Property.

EYE 2000 s.r.o. / Ohmova 271 / 109 00 Praha 10 / Czech Republic / Provozovna / Polubenská 614 / 468 61 Desná / Czech Republic
T +420 271 961 170 / www.eye2000.cz / info@eye2000.cz



ateliér
kreativ

JORDANA

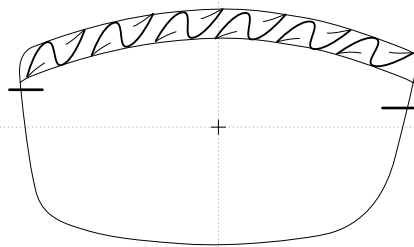

1,3 mm

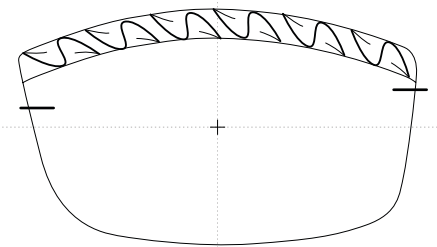

JUDITA

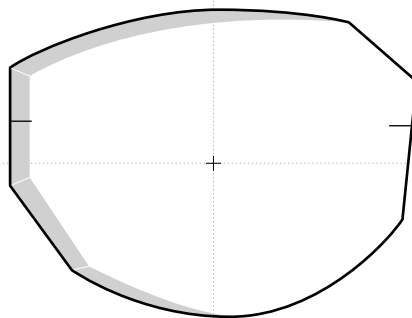

0,5 mm

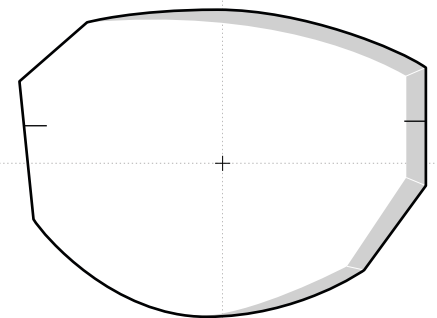

JULIE

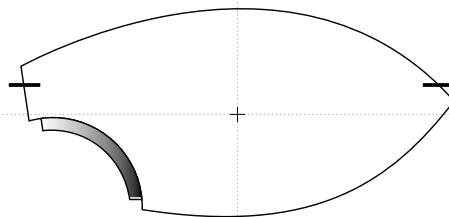

2 mm

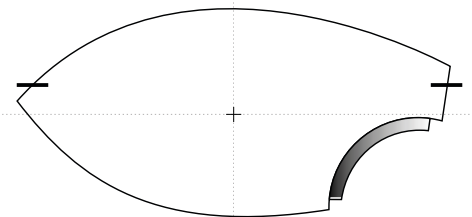

JULIUS

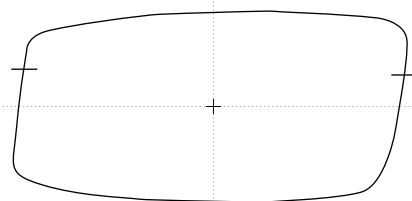

0,5 mm

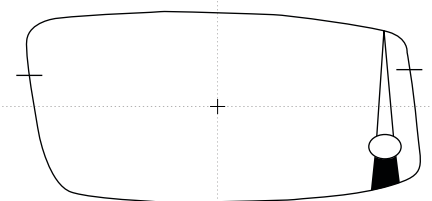

Tyto kreativní tvary brýlových čoček byly navrženy a vyrobeny v ateliéru kreativ při společnosti EYE 2000 s.r.o. a jsou chráněny Úřadem průmyslového vlastnictví jako průmyslový vzor.
These creative glasses lens shapes were designed and produced by ateliér kreativ by EYE 2000 s.r.o. company and are patented and protected by the Authority of the Industrial Property.

EYE 2000 s.r.o. / Ohmova 271 / 109 00 Praha 10 / Czech Republic / Provozovna / Polubenská 614 / 468 61 Desná / Czech Republic
T +420 271 961 170 / www.eye2000.cz / info@eye2000.cz



atelier
kreativ

KALI

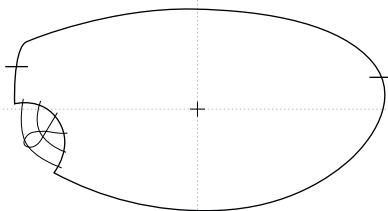

0,5 mm

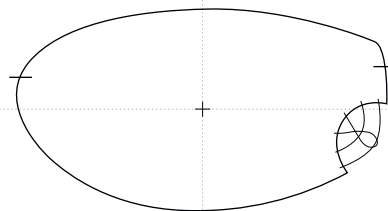

KAMIL

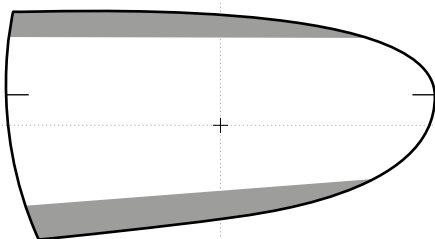

0 mm

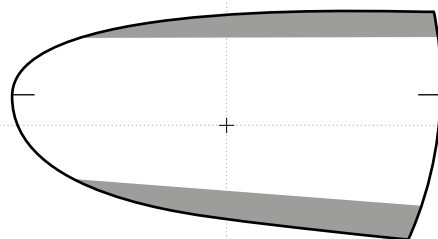

KAMILA

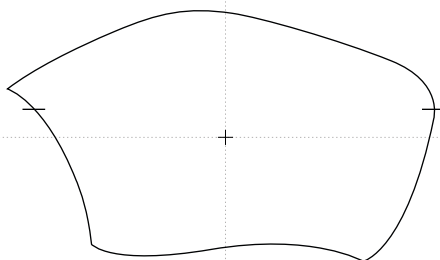

0 mm

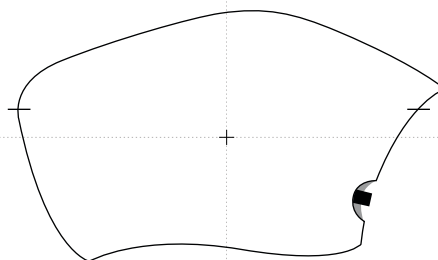

KAPRADI

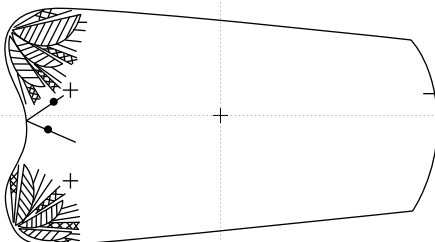

0,5 mm

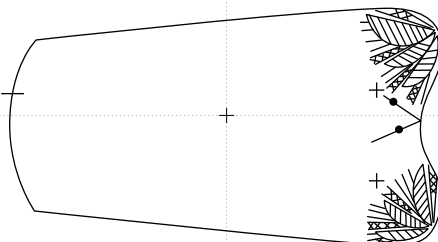

Tyto kreativní tvary brýlových čoček byly navrženy a vyrobeny v ateliéru kreativ při společnosti EYE 2000 s.r.o. a jsou chráněny Úřadem průmyslového vlastnictví jako průmyslový vzor.
These creative glasses lens shapes were designed and produced by atelier kreativ by EYE 2000 s.r.o. company and are patented and protected by the Authority of the Industrial Property.

EYE 2000 s.r.o. / Ohmova 271 / 109 00 Praha 10 / Czech Republic / Provozovna / Polubenská 614 / 468 61 Desná / Czech Republic
T +420 271 961 170 / www.eyeye2000.cz / info@eyeye2000.cz



KARA

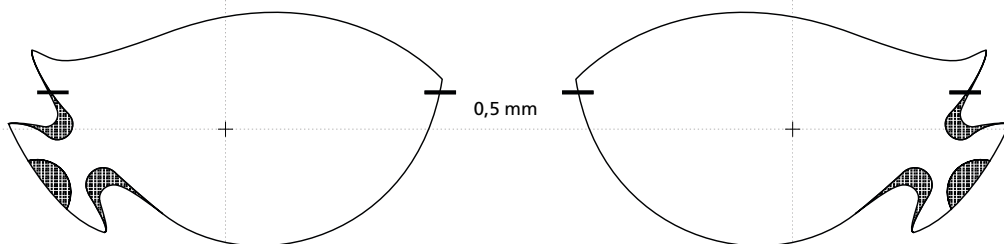

KARINA

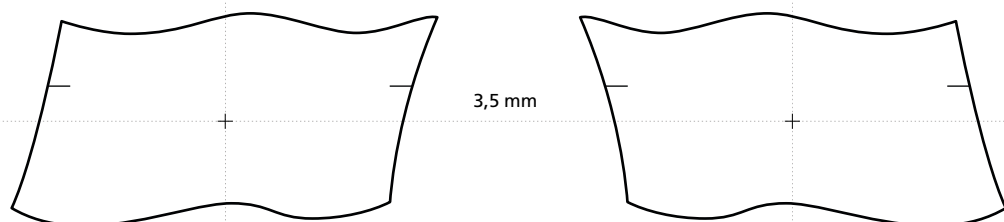

KARLA

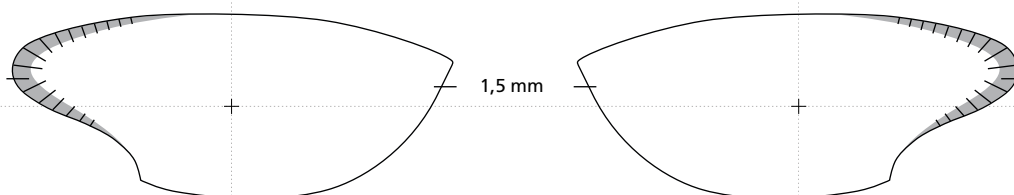

KAROLINA

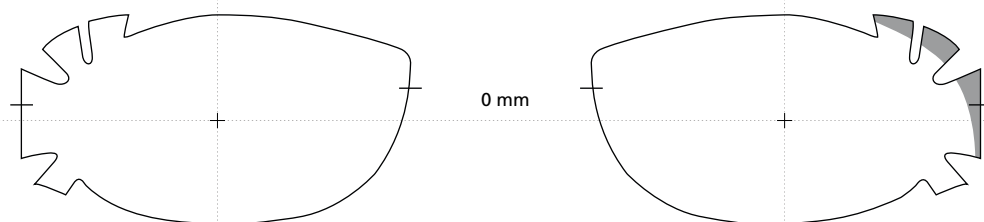

Tyto kreativní tvary brýlových čoček byly navrženy a vyrobeny v ateliéru kreativ při společnosti EYE 2000 s.r.o. a jsou chráněny Úřadem průmyslového vlastnictví jako průmyslový vzor.
These creative glasses lens shapes were designed and produced by atelier kreativ by EYE 2000 s.r.o. company and are patented and protected by the Authority of the Industrial Property.

EYE 2000 s.r.o. / Ohmova 271 / 109 00 Praha 10 / Czech Republic / Provozovna / Polubenská 614 / 468 61 Desná / Czech Republic
T +420 271 961 170 / www.eye2000.cz / info@eye2000.cz



atelier
kreativ

KAT

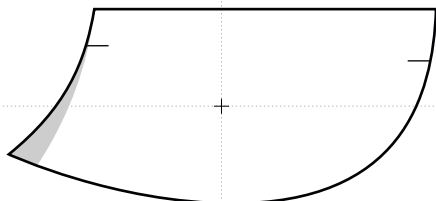

1 mm

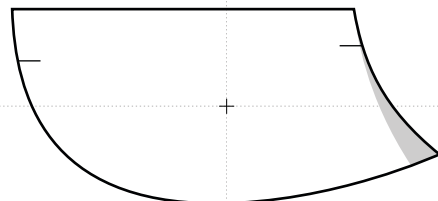

KATERINA

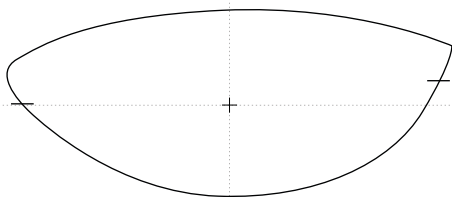

1,6 mm

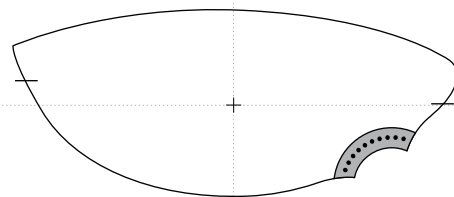

KLARA

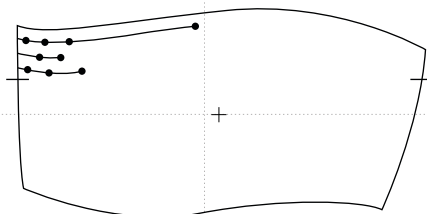

0,5 mm

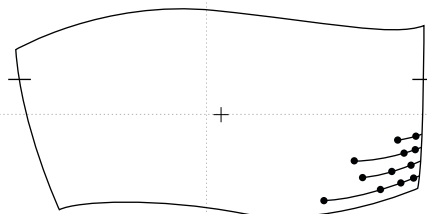

KLEMENTYNA

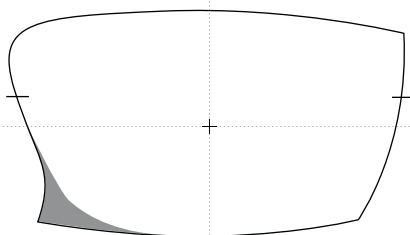

0,6 mm

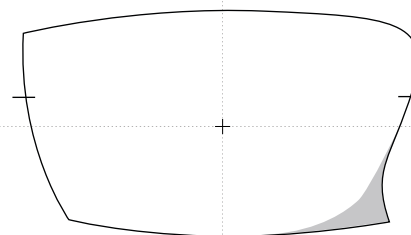

Tyto kreativní tvary brýlových čoček byly navrženy a vyrobeny v ateliéru kreativ při společnosti EYE 2000 s.r.o. a jsou chráněny Úřadem průmyslového vlastnictví jako průmyslový vzor.
These creative glasses lens shapes were designed and produced by atelier kreativ by EYE 2000 s.r.o. company and are patented and protected by the Authority of the Industrial Property.

EYE 2000 s.r.o. / Ohmova 271 / 109 00 Praha 10 / Czech Republic / Provozovna / Polubenská 614 / 468 61 Desná / Czech Republic
T +420 271 961 170 / www.eye2000.cz / info@eye2000.cz

KOLECKA

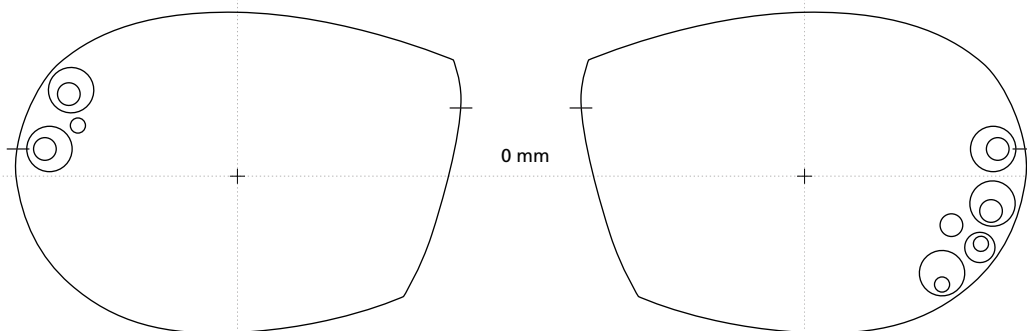

KOLETA

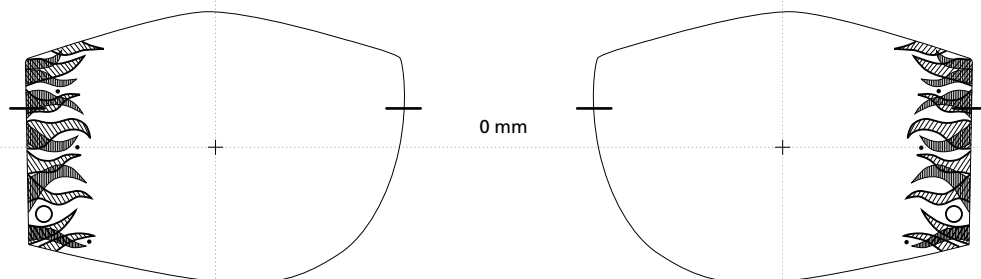

KOZOROH

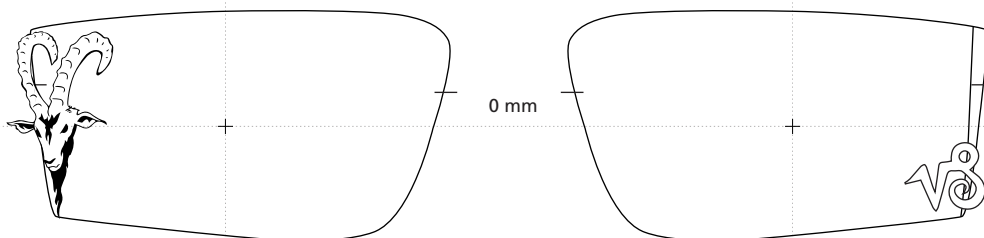

KRISTYNKA

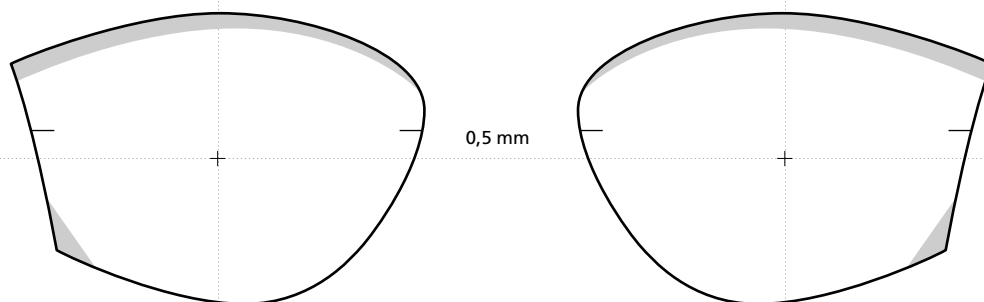



atelier
kreativ

KRYSTOF

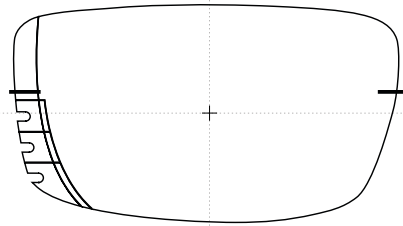

0,5 mm

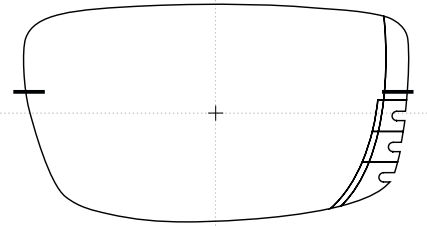

KRYTON

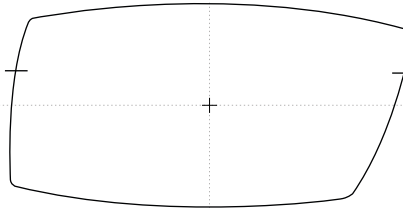

1 mm

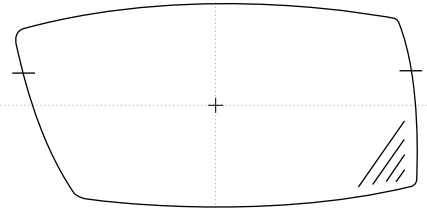

KVETA

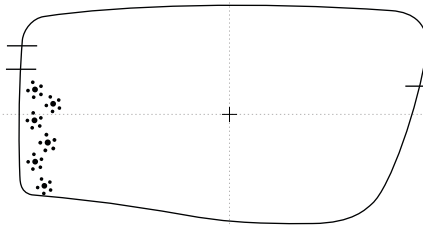

1 mm

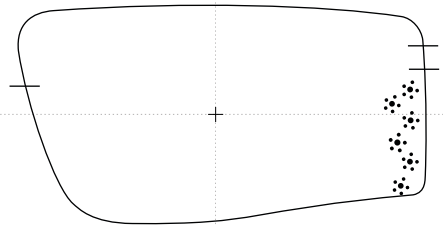

LADA

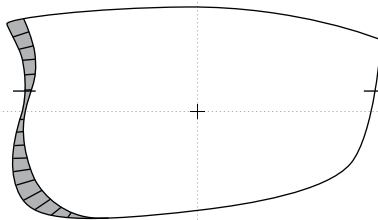

0,9 mm

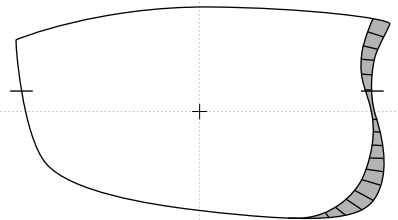

Tyto kreativní tvary brýlových čoček byly navrženy a vyrobeny v ateliéru kreativ při společnosti EYE 2000 s.r.o. a jsou chráněny Úřadem průmyslového vlastnictví jako průmyslový vzor.
These creative glasses lens shapes were designed and produced by atelier kreativ by EYE 2000 s.r.o. company and are patented and protected by the Authority of the Industrial Property.

EYE 2000 s.r.o. / Ohmova 271 / 109 00 Praha 10 / Czech Republic / Provozovna / Polubenská 614 / 468 61 Desná / Czech Republic
T +420 271 961 170 / www.eye2000.cz / info@eye2000.cz



ateliér
kreativ

LAJLA

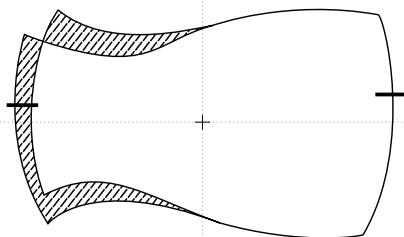

0 mm

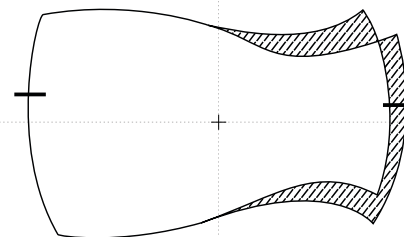

LAURA

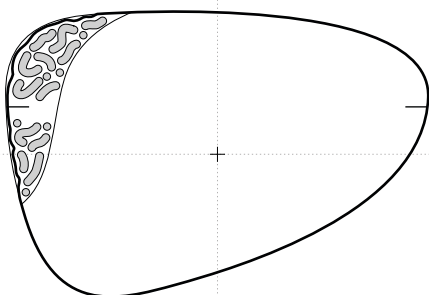

0 mm

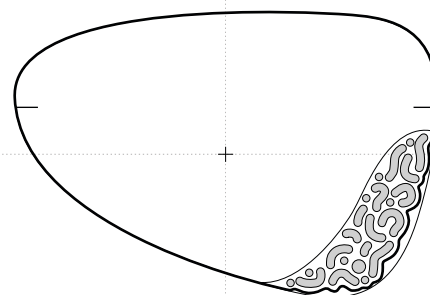

LEONA

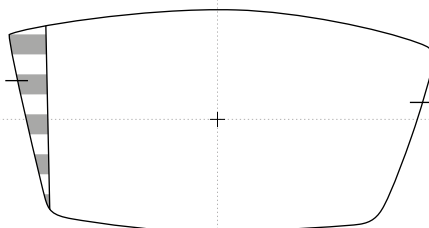

1 mm

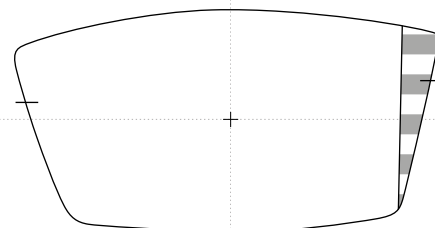

LEONARD

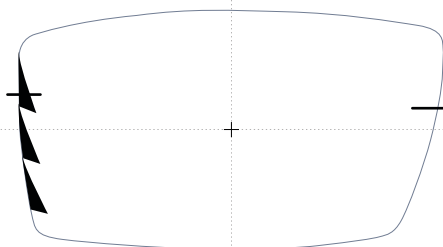

0,7 mm

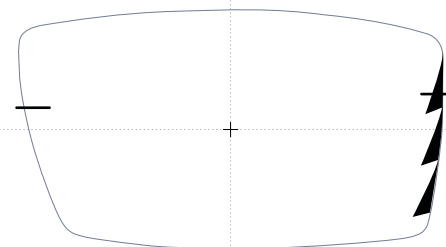

Tyto kreativní tvary brýlových čoček byly navrženy a vyrobeny v ateliéru kreativ při společnosti EYE 2000 s.r.o. a jsou chráněny Úřadem průmyslového vlastnictví jako průmyslový vzor.
These creative glasses lens shapes were designed and produced by ateliér kreativ by EYE 2000 s.r.o. company and are patented and protected by the Authority of the Industrial Property.

EYE 2000 s.r.o. / Ohmova 271 / 109 00 Praha 10 / Czech Republic / Provozovna / Polubenská 614 / 468 61 Desná / Czech Republic
T +420 271 961 170 / www.eye2000.cz / info@eye2000.cz



ateliér
kreativ

LEONTYNA

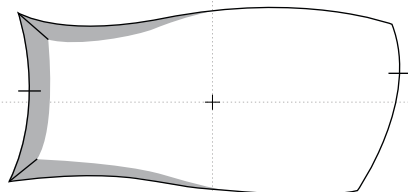

0 mm

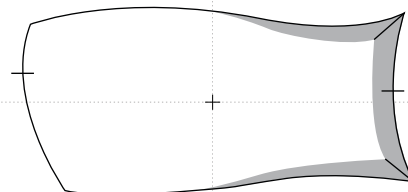

LETICIE

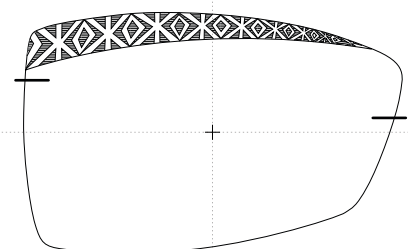

1 mm

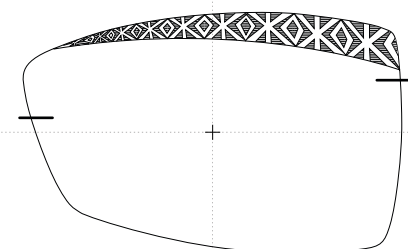

LEV

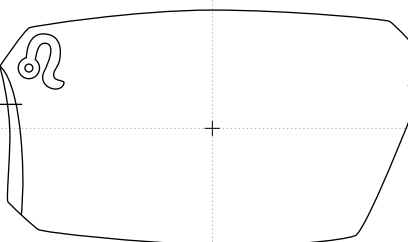

0,5 mm

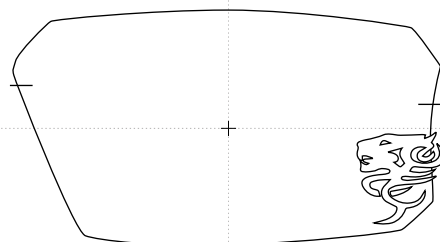

LILIANA

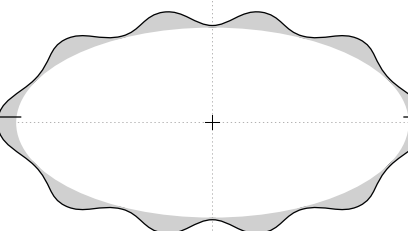

0 mm

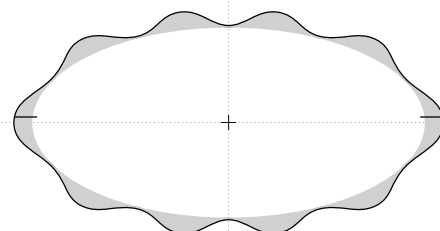

Tyto kreativní tvary brýlových čoček byly navrženy a vyrobeny v ateliéru kreativ při společnosti EYE 2000 s.r.o. a jsou chráněny Úřadem průmyslového vlastnictví jako průmyslový vzor. These creative glasses lens shapes were designed and produced by ateliér kreativ by EYE 2000 s.r.o. company and are patented and protected by the Authority of the Industrial Property.

EYE 2000 s.r.o. / Ohmova 271 / 109 00 Praha 10 / Czech Republic / Provozovna / Polubenská 614 / 468 61 Desná / Czech Republic
T +420 271 961 170 / www.eye2000.cz / info@eye2000.cz



ateliér
kreativ

LILIE

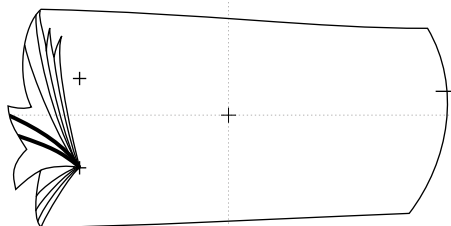

0 mm

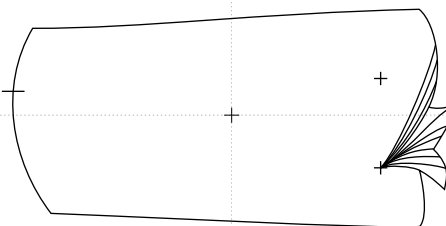

LINDA

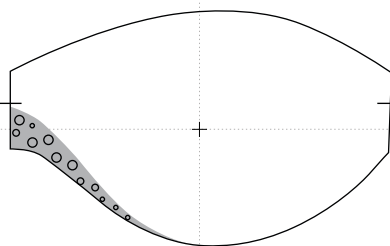

0 mm

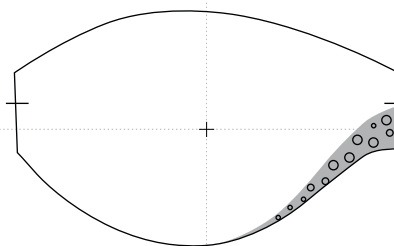

LJUBA

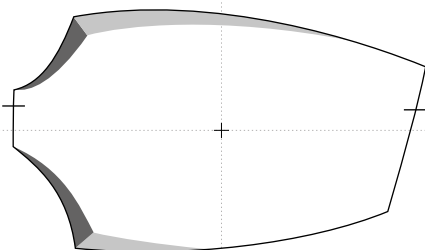

1,5 mm

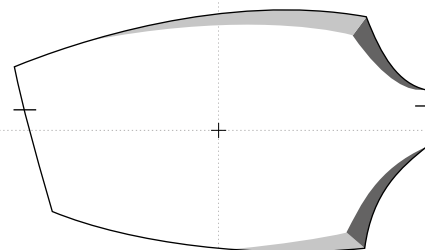

LOTA

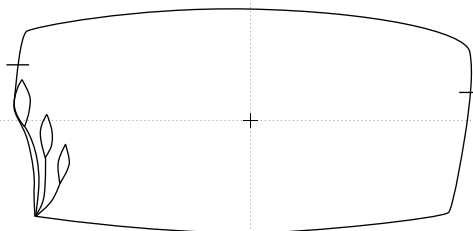

0 mm

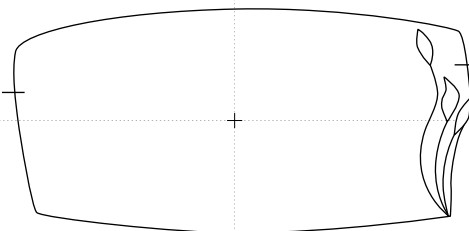

Tyto kreativní tvary brýlových čoček byly navrženy a vyrobeny v ateliéru kreativ při společnosti EYE 2000 s.r.o. a jsou chráněny Úřadem průmyslového vlastnictví jako průmyslový vzor.
These creative glasses lens shapes were designed and produced by ateliér kreativ by EYE 2000 s.r.o. company and are patented and protected by the Authority of the Industrial Property.

EYE 2000 s.r.o. / Ohmova 271 / 109 00 Praha 10 / Czech Republic / Provozovna / Polubenská 614 / 468 61 Desná / Czech Republic
T +420 271 961 170 / www.eyeye2000.cz / info@eyeye2000.cz



atelier
kreativ

LUCIE

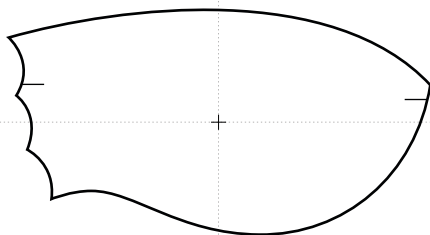

0,5 mm

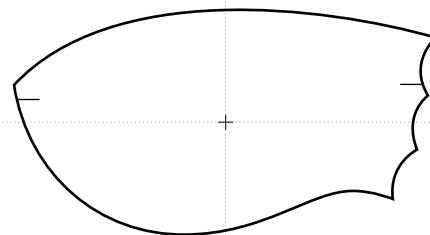

LUDOVITA

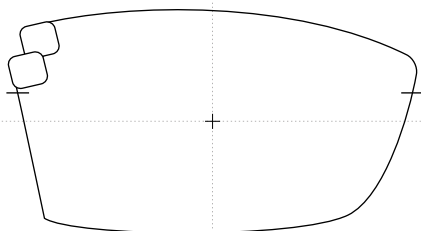

1 mm

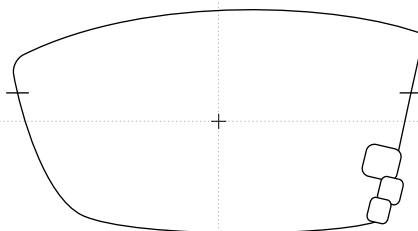

LUKAS

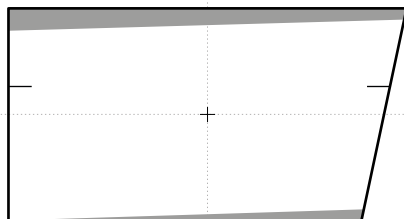

2 mm

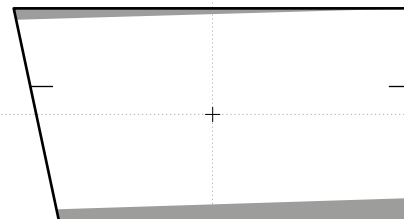

LUTETIA

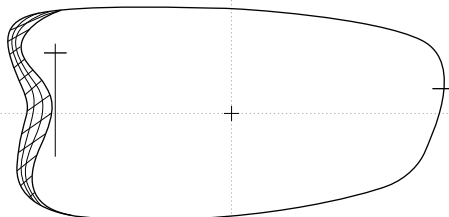

0 mm

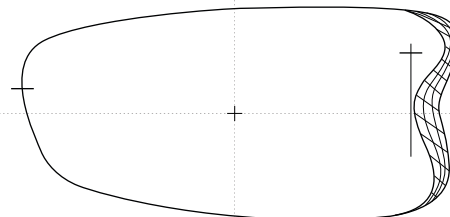

Tyto kreativní tvary brýlových čoček byly navrženy a vyrobeny v ateliéru kreativ při společnosti EYE 2000 s.r.o. a jsou chráněny Úřadem průmyslového vlastnictví jako průmyslový vzor.
These creative glasses lens shapes were designed and produced by atelier kreativ by EYE 2000 s.r.o. company and are patented and protected by the Authority of the Industrial Property.

EYE 2000 s.r.o. / Ohmova 271 / 109 00 Praha 10 / Czech Republic / Provozovna / Polubenská 614 / 468 61 Desná / Czech Republic
T +420 271 961 170 / www.eye2000.cz / info@eye2000.cz



ateliér
kreativ

LYDIE

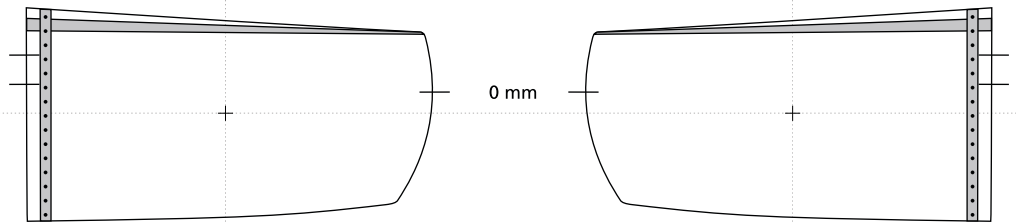

MAGDALENA

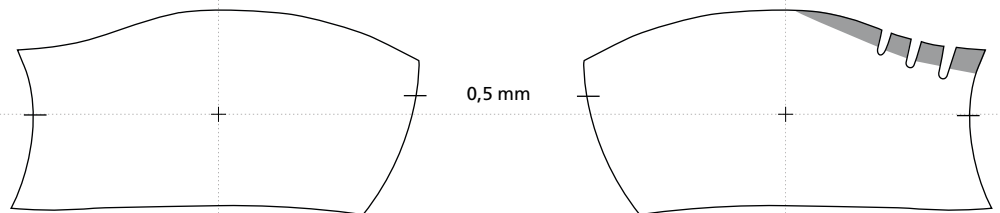

MAGNA

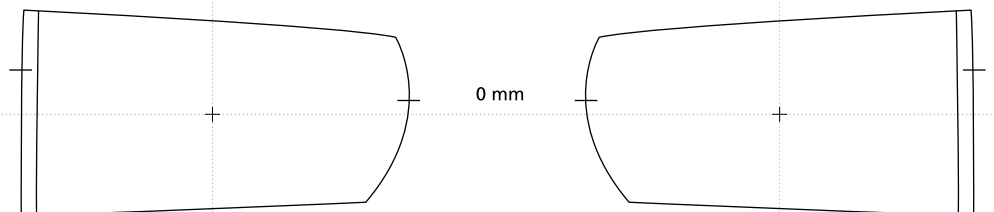

MAHULENA

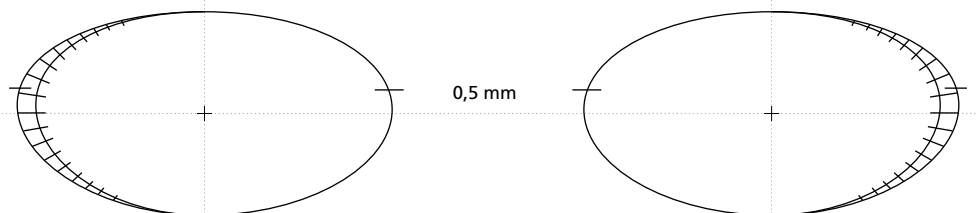

Tyto kreativní tvary brýlových čoček byly navrženy a vyrobeny v ateliéru kreativ při společnosti EYE 2000 s.r.o. a jsou chráněny Úřadem průmyslového vlastnictví jako průmyslový vzor.
These creative glasses lens shapes were designed and produced by ateliér kreativ by EYE 2000 s.r.o. company and are patented and protected by the Authority of the Industrial Property.

EYE 2000 s.r.o. / Ohmova 271 / 109 00 Praha 10 / Czech Republic / Provozovna / Polubenská 614 / 468 61 Desná / Czech Republic
T +420 271 961 170 / www.eyeye2000.cz / info@eyeye2000.cz



ateliér
kreativ

MARCELA

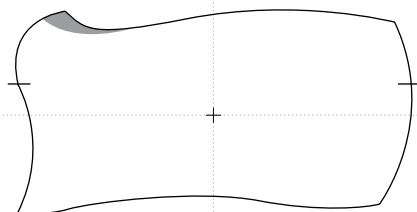

0 mm

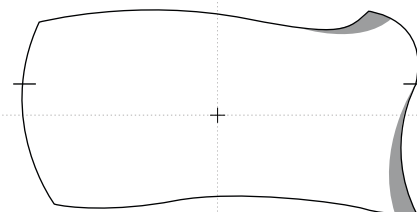

MAREK

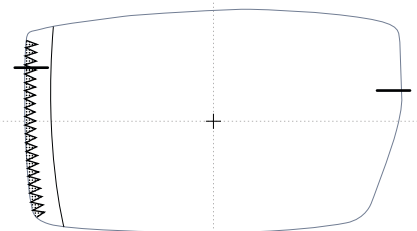

0 mm

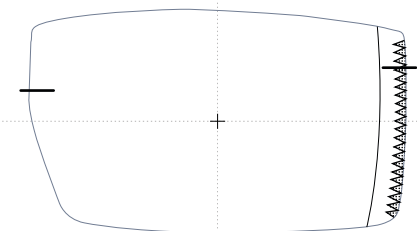

MARGIT

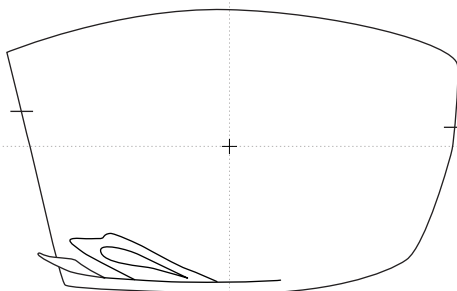

0,5 mm

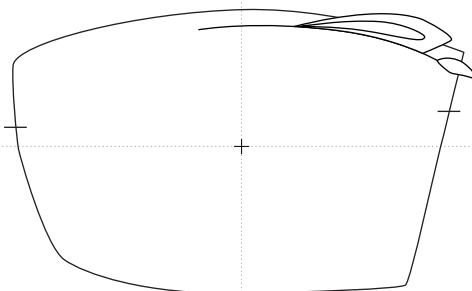

MARIAN

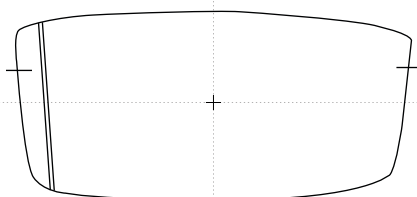

0,5 mm

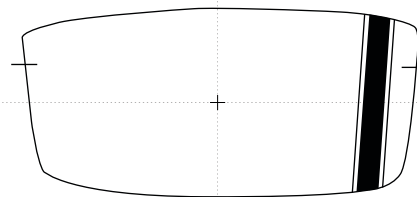

Tyto kreativní tvary brýlových čoček byly navrženy a vyrobeny v ateliéru kreativ při společnosti EYE 2000 s.r.o. a jsou chráněny Úřadem průmyslového vlastnictví jako průmyslový vzor.
These creative glasses lens shapes were designed and produced by ateliér kreativ by EYE 2000 s.r.o. company and are patented and protected by the Authority of the Industrial Property.

EYE 2000 s.r.o. / Ohmova 271 / 109 00 Praha 10 / Czech Republic / Provozovna / Polubenská 614 / 468 61 Desná / Czech Republic
T +420 271 961 170 / www.eye2000.cz / info@eye2000.cz



atelier
kreativ

MARIKA

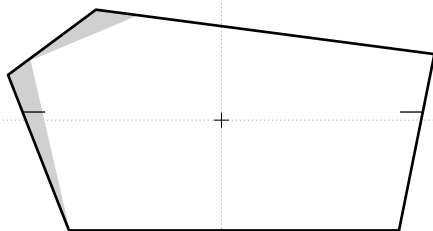

1,5 mm

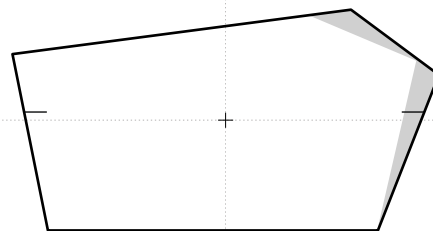

MARKETA

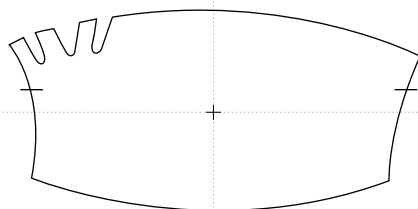

2 mm

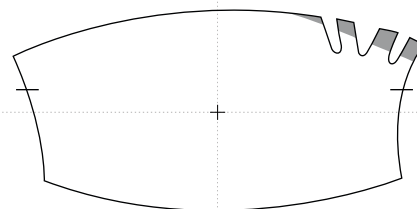

MARTA

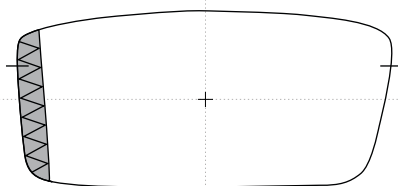

0,5 mm

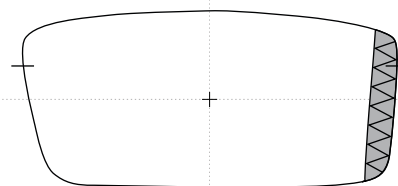

MARTIN

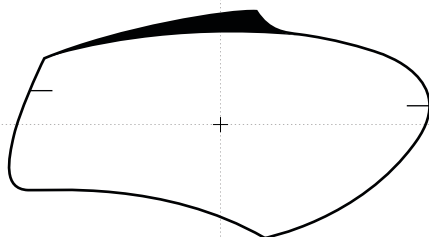

0 mm

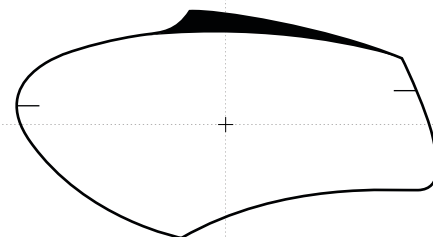

Tyto kreativní tvary brýlových čoček byly navrženy a vyrobeny v ateliéru kreativ při společnosti EYE 2000 s.r.o. a jsou chráněny Úřadem průmyslového vlastnictví jako průmyslový vzor.
These creative glasses lens shapes were designed and produced by atelier kreativ by EYE 2000 s.r.o. company and are patented and protected by the Authority of the Industrial Property.

EYE 2000 s.r.o. / Ohmova 271 / 109 00 Praha 10 / Czech Republic / Provozovna / Polubenská 614 / 468 61 Desná / Czech Republic
T +420 271 961 170 / www.eye2000.cz / info@eye2000.cz



atelier
kreativ

MARTINA

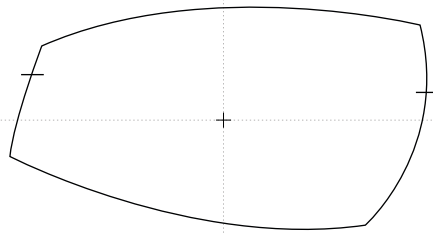

0 mm

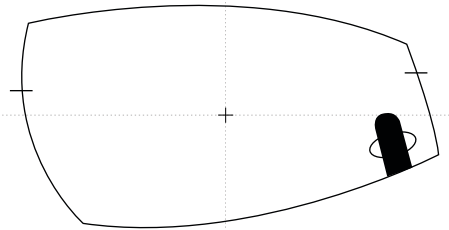

MARUSKA

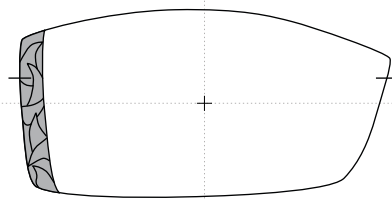

0,6 mm

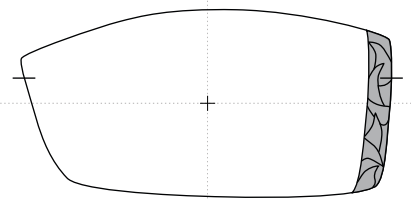

MASLE

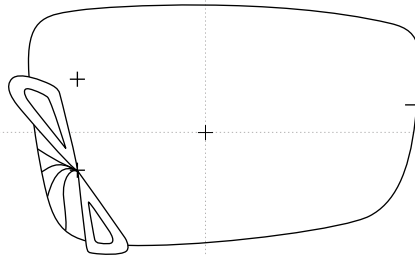

0 mm

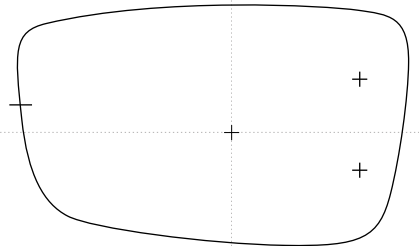

MATYAS

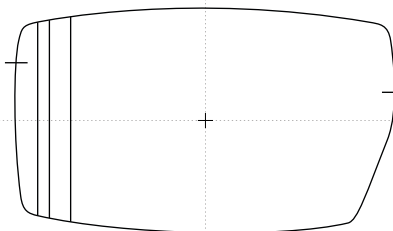

0 mm

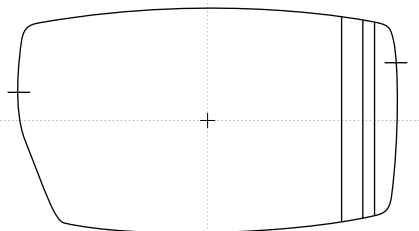

Tyto kreativní tvary brýlových čoček byly navrženy a vyrobeny v ateliéru kreativ při společnosti EYE 2000 s.r.o. a jsou chráněny Úřadem průmyslového vlastnictví jako průmyslový vzor.
These creative glasses lens shapes were designed and produced by atelier kreativ by EYE 2000 s.r.o. company and are patented and protected by the Authority of the Industrial Property.

EYE 2000 s.r.o. / Ohmova 271 / 109 00 Praha 10 / Czech Republic / Provozovna / Polubenská 614 / 468 61 Desná / Czech Republic
T +420 271 961 170 / www.eye2000.cz / info@eye2000.cz



ateliér
kreativ

MATYLDA

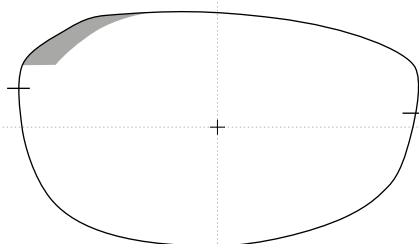

0,25 mm

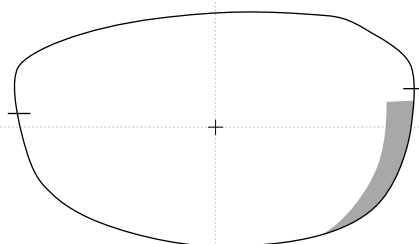

MAURICIUS

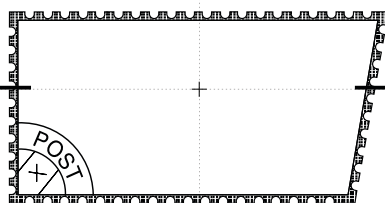

2,4 mm

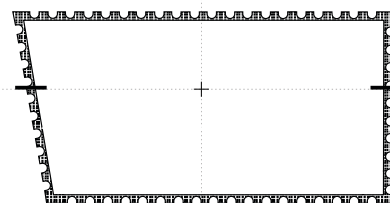

MAX

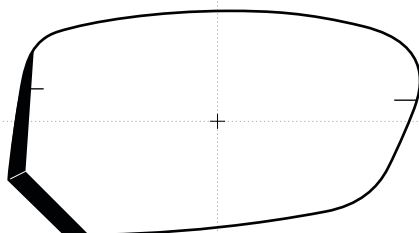

0,5 mm

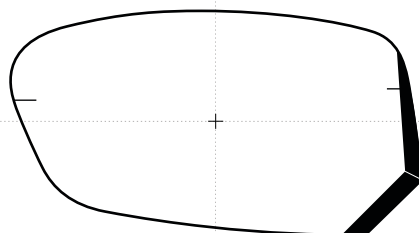

MEDARD

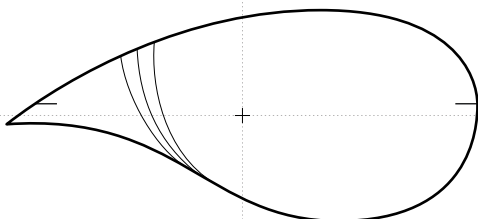

0 mm

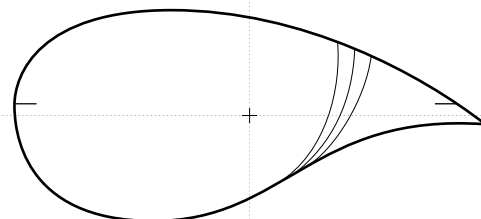

Tyto kreativní tvary brýlových čoček byly navrženy a vyrobeny v ateliéru kreativ při společnosti EYE 2000 s.r.o. a jsou chráněny Úřadem průmyslového vlastnictví jako průmyslový vzor. These creative glasses lens shapes were designed and produced by ateliér kreativ by EYE 2000 s.r.o. company and are patented and protected by the Authority of the Industrial Property.

EYE 2000 s.r.o. / Ohmova 271 / 109 00 Praha 10 / Czech Republic / Provozovna / Polubenská 614 / 468 61 Desná / Czech Republic
T +420 271 961 170 / www.eye2000.cz / info@eye2000.cz



ateliér
kreativ

MICHAELA

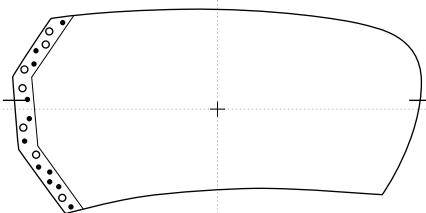

0 mm

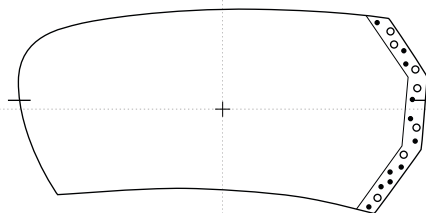

MILADA

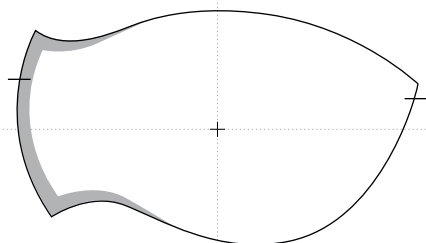

0,5 mm

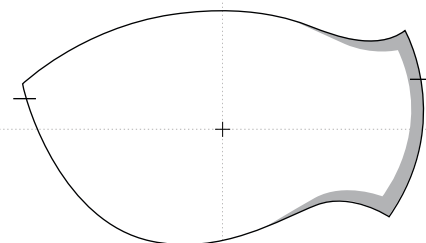

MILDRED

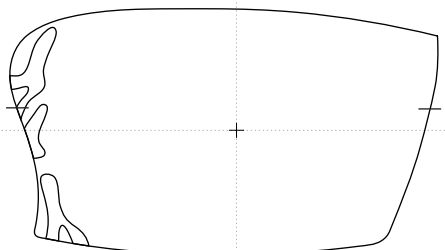

1 mm

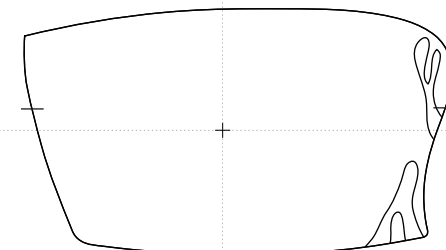

MILENA

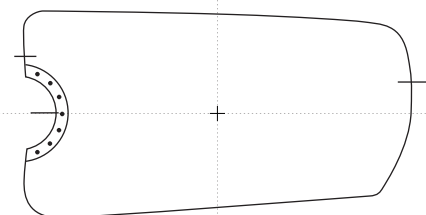

0 mm

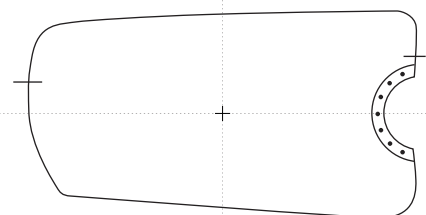

Tyto kreativní tvary brýlových čoček byly navrženy a vyrobeny v ateliéru kreativ při společnosti EYE 2000 s.r.o. a jsou chráněny Úřadem průmyslového vlastnictví jako průmyslový vzor.
These creative glasses lens shapes were designed and produced by ateliér kreativ by EYE 2000 s.r.o. company and are patented and protected by the Authority of the Industrial Property.

EYE 2000 s.r.o. / Ohmova 271 / 109 00 Praha 10 / Czech Republic / Provozovna / Polubenská 614 / 468 61 Desná / Czech Republic
T +420 271 961 170 / www.eyeye2000.cz / info@eyeye2000.cz



ateliér
kreativ

MILUSE

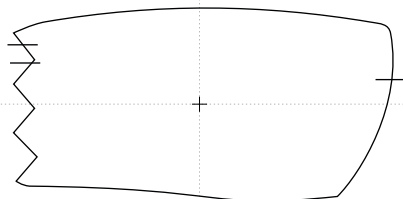

0 mm

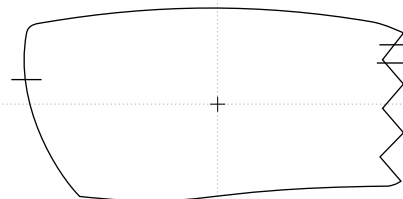

MIRIAM

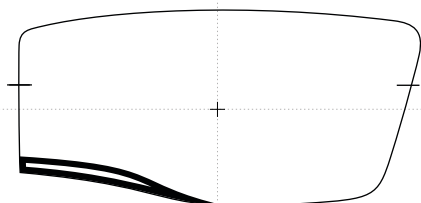

0,5 mm

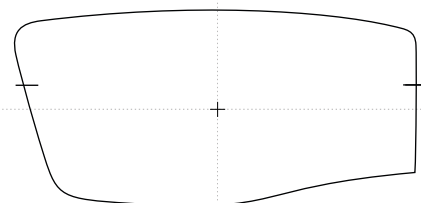

MIRKA

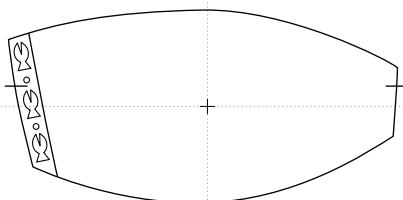

0 mm

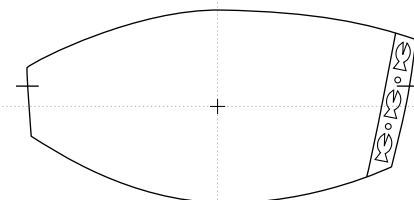

MONA

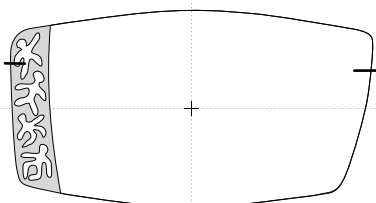

0,5 mm

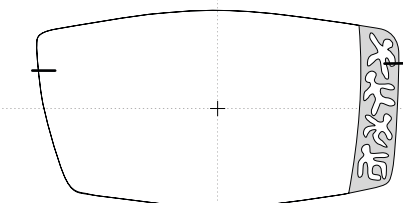

Tyto kreativní tvary brýlových čoček byly navrženy a vyrobeny v ateliéru kreativ při společnosti EYE 2000 s.r.o. a jsou chráněny Úřadem průmyslového vlastnictví jako průmyslový vzor. These creative glasses lens shapes were designed and produced by ateliér kreativ by EYE 2000 s.r.o. company and are patented and protected by the Authority of the Industrial Property.

EYE 2000 s.r.o. / Ohmova 271 / 109 00 Praha 10 / Czech Republic / Provozovna / Polubenská 614 / 468 61 Desná / Czech Republic
T +420 271 961 170 / www.eyeye2000.cz / info@eyeye2000.cz



atelier
kreativ

MONIKA

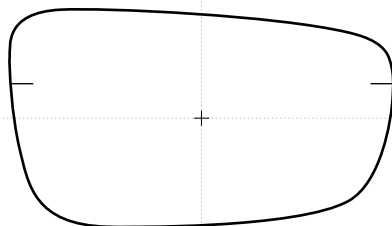

0 mm

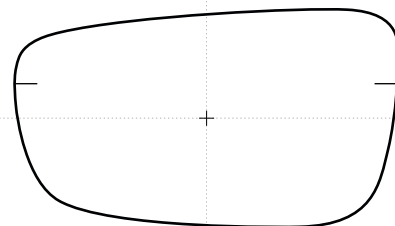

MOTYL

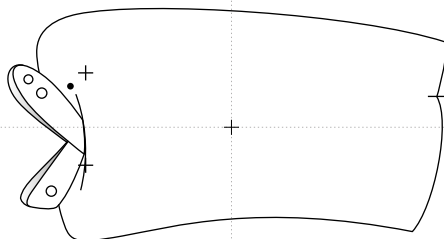

1 mm

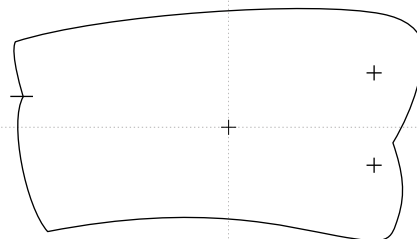

NATALKA

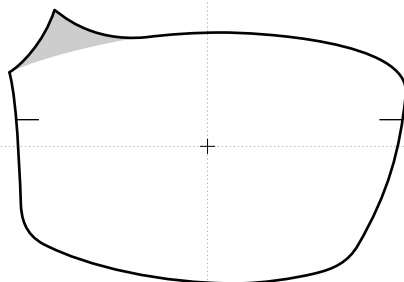

0,5 mm

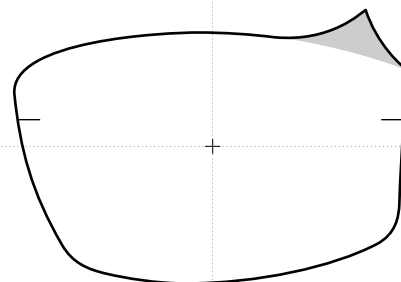

NATREA

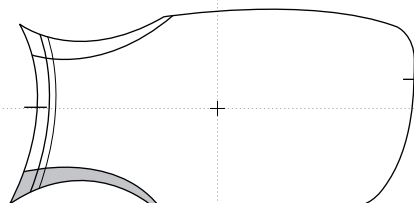

0 mm

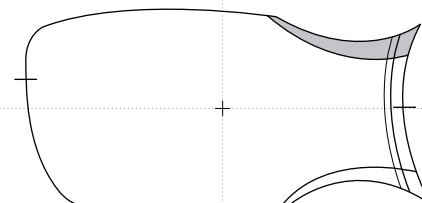

Tyto kreativní tvary brýlových čoček byly navrženy a vyrobeny v ateliéru kreativ při společnosti EYE 2000 s.r.o. a jsou chráněny Úřadem průmyslového vlastnictví jako průmyslový vzor.
These creative glasses lens shapes were designed and produced by atelier kreativ by EYE 2000 s.r.o. company and are patented and protected by the Authority of the Industrial Property.

EYE 2000 s.r.o. / Ohmova 271 / 109 00 Praha 10 / Czech Republic / Provozovna / Polubenská 614 / 468 61 Desná / Czech Republic
T +420 271 961 170 / www.eye2000.cz / info@eye2000.cz



ateliér
kreativ

NEFERTITI

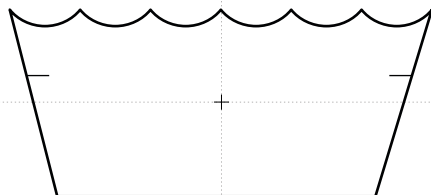

3 mm

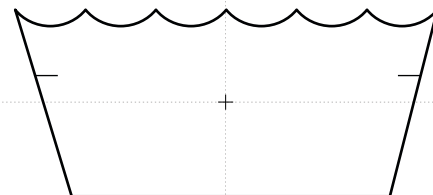

NEFRU

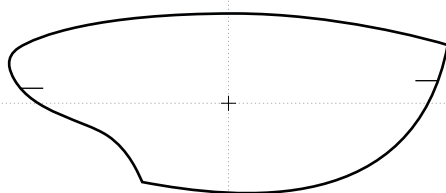

1,5 mm

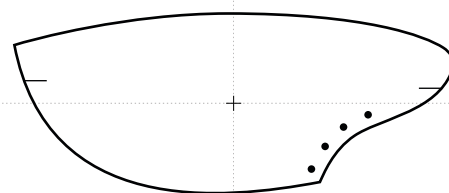

NELA

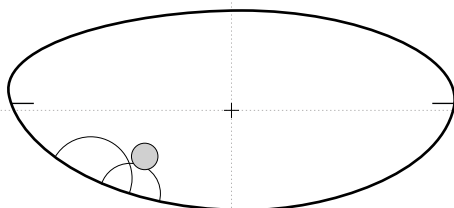

0 mm

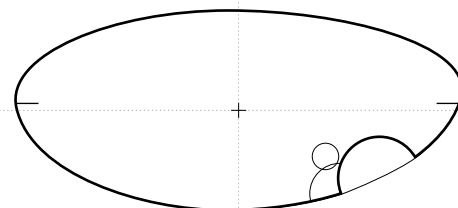

NEONA

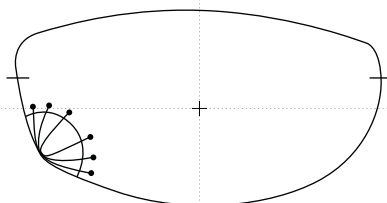

0 mm

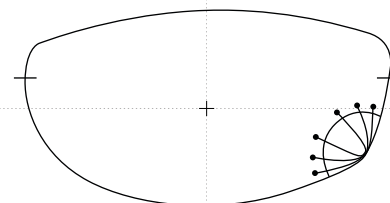

Tyto kreativní tvary brýlových čoček byly navrženy a vyrobeny v ateliéru kreativ při společnosti EYE 2000 s.r.o. a jsou chráněny Úřadem průmyslového vlastnictví jako průmyslový vzor.
These creative glasses lens shapes were designed and produced by ateliér kreativ by EYE 2000 s.r.o. company and are patented and protected by the Authority of the Industrial Property.

EYE 2000 s.r.o. / Ohmova 271 / 109 00 Praha 10 / Czech Republic / Provozovna / Polubenská 614 / 468 61 Desná / Czech Republic
T +420 271 961 170 / www.eye2000.cz / info@eye2000.cz



ateliér
kreativ

NERO

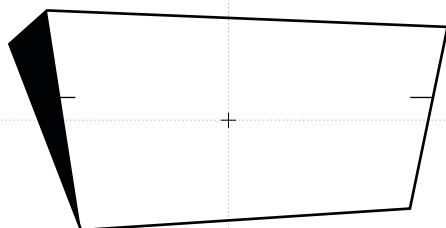

2 mm

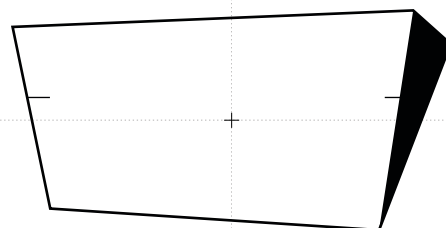

NICKY

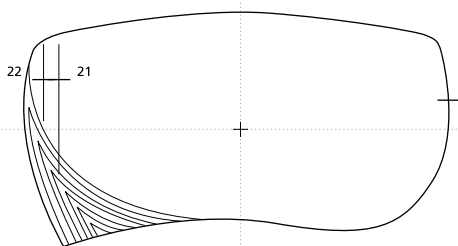

0 mm

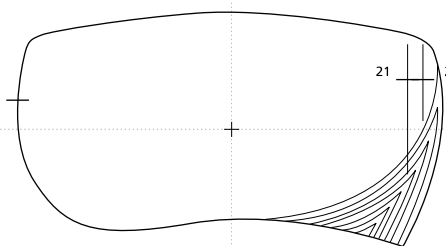

NIKOLA

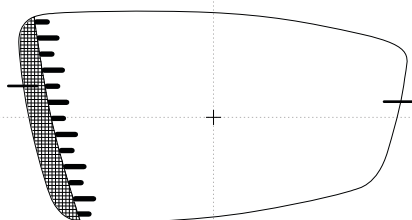

0,9 mm

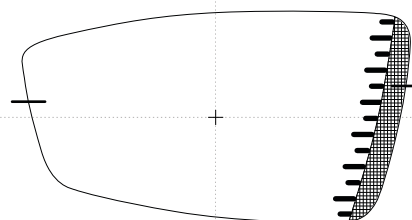

NIKOLAS

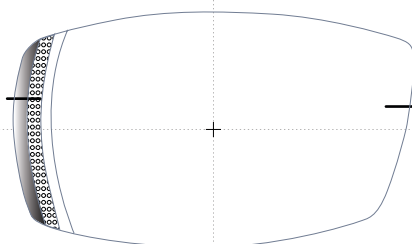

0,7 mm

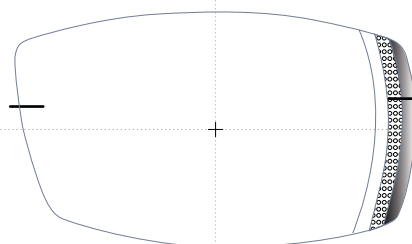

Tyto kreativní tvary brýlových čoček byly navrženy a vyrobeny v ateliéru kreativ při společnosti EYE 2000 s.r.o. a jsou chráněny Úřadem průmyslového vlastnictví jako průmyslový vzor.
These creative glasses lens shapes were designed and produced by ateliér kreativ by EYE 2000 s.r.o. company and are patented and protected by the Authority of the Industrial Property.

EYE 2000 s.r.o. / Ohmova 271 / 109 00 Praha 10 / Czech Republic / Provozovna / Polubenská 614 / 468 61 Desná / Czech Republic
T +420 271 961 170 / www.eye2000.cz / info@eye2000.cz



ateliér
kreativ

NINA

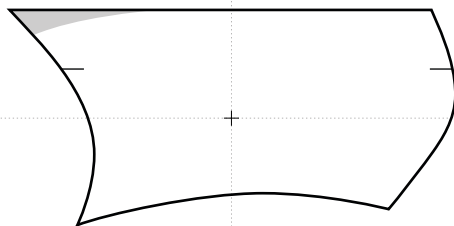

0,5 mm

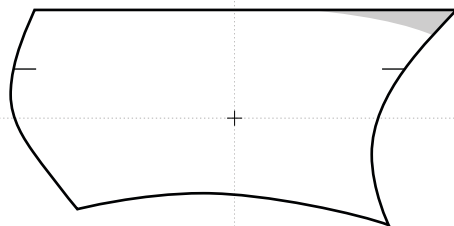

NITROGENA

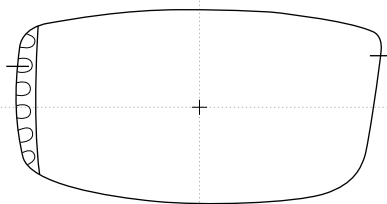

0 mm

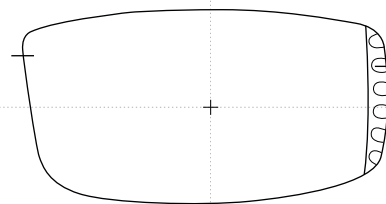

NORA

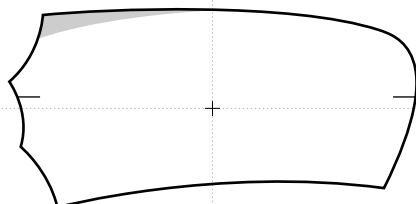

0 mm

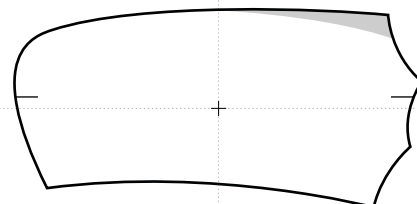

OLGA

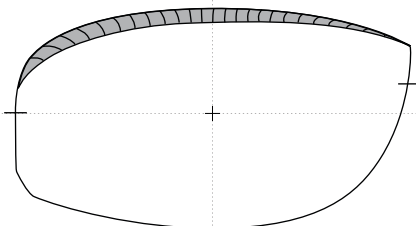

0 mm

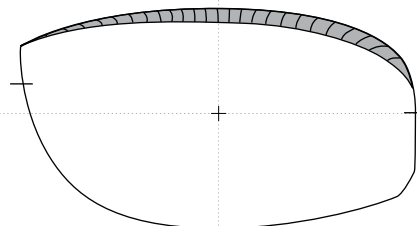

Tyto kreativní tvary brýlových čoček byly navrženy a vyrobeny v ateliéru kreativ při společnosti EYE 2000 s.r.o. a jsou chráněny Úřadem průmyslového vlastnictví jako průmyslový vzor. These creative glasses lens shapes were designed and produced by ateliér kreativ by EYE 2000 s.r.o. company and are patented and protected by the Authority of the Industrial Property.

EYE 2000 s.r.o. / Ohmova 271 / 109 00 Praha 10 / Czech Republic / Provozovna / Polubenská 614 / 468 61 Desná / Czech Republic
T +420 271 961 170 / www.eye2000.cz / info@eye2000.cz



atelier
kreativ

OLIVER

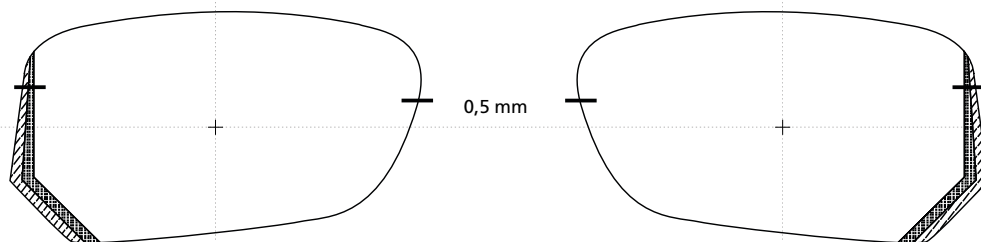

OLIVIE

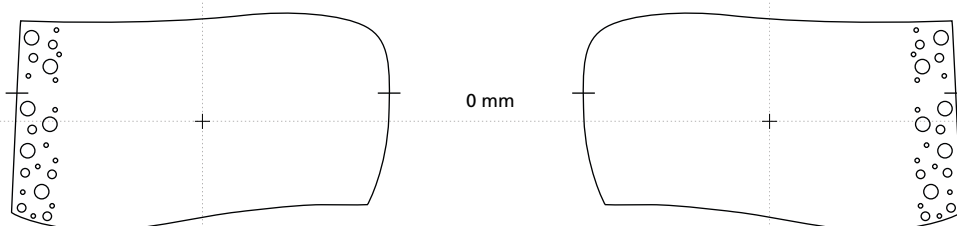

ONDRAS

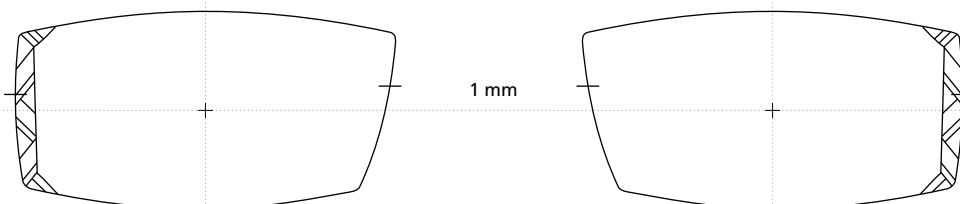

ORCHIDEJ

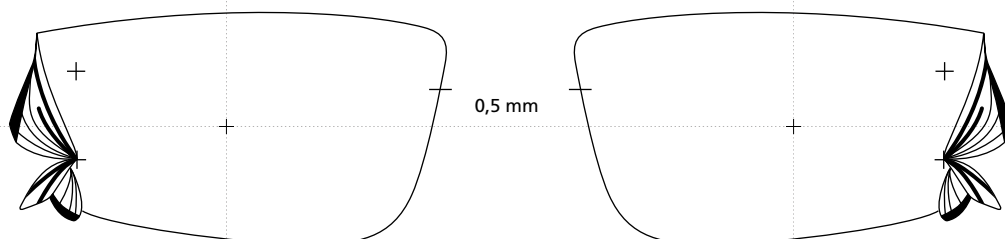

Tyto kreativní tvary brýlových čoček byly navrženy a vyrobeny v ateliéru kreativ při společnosti EYE 2000 s.r.o. a jsou chráněny Úřadem průmyslového vlastnictví jako průmyslový vzor.
These creative glasses lens shapes were designed and produced by atelier kreativ by EYE 2000 s.r.o. company and are patented and protected by the Authority of the Industrial Property.

EYE 2000 s.r.o. / Ohmova 271 / 109 00 Praha 10 / Czech Republic / Provozovna / Polubenská 614 / 468 61 Desná / Czech Republic
T +420 271 961 170 / www.eye2000.cz / info@eye2000.cz



ateliér
kreativ

OSKAR

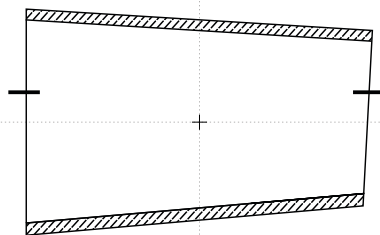

0,5 mm

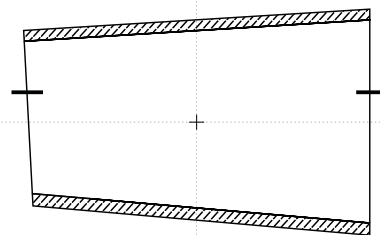

PALLADIA

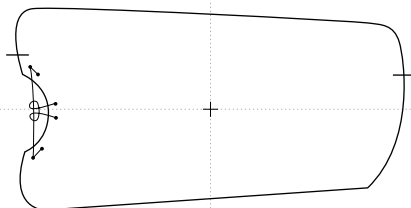

0 mm

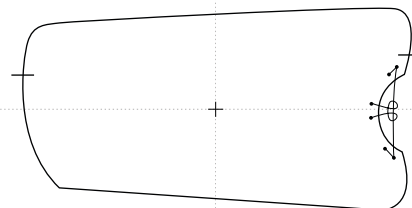

PALOMA

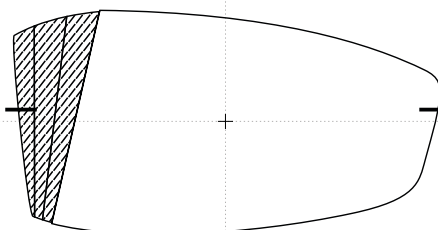

0,6 mm

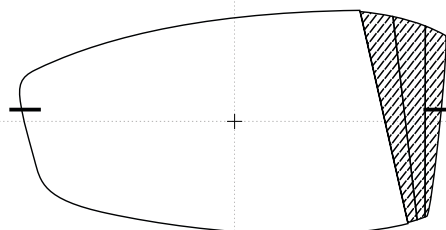

PANNA

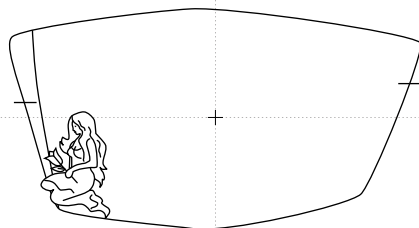

1,5 mm

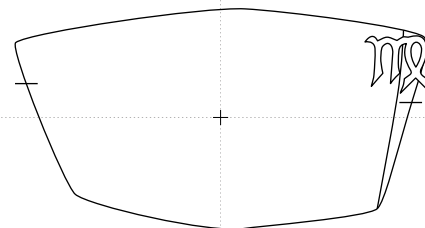

Tyto kreativní tvary brýlových čoček byly navrženy a vyrobeny v ateliéru kreativ při společnosti EYE 2000 s.r.o. a jsou chráněny Úřadem průmyslového vlastnictví jako průmyslový vzor. These creative glasses lens shapes were designed and produced by ateliér kreativ by EYE 2000 s.r.o. company and are patented and protected by the Authority of the Industrial Property.

EYE 2000 s.r.o. / Ohmova 271 / 109 00 Praha 10 / Czech Republic / Provozovna / Polubenská 614 / 468 61 Desná / Czech Republic
T +420 271 961 170 / www.eye2000.cz / info@eye2000.cz



atelier
kreativ

PAT

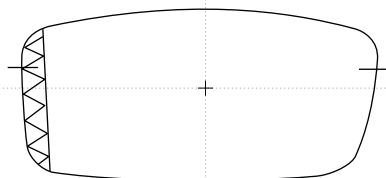

0 mm

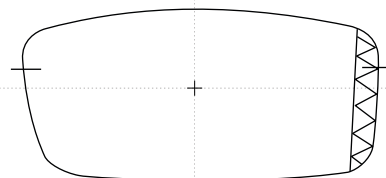

PATRICIE

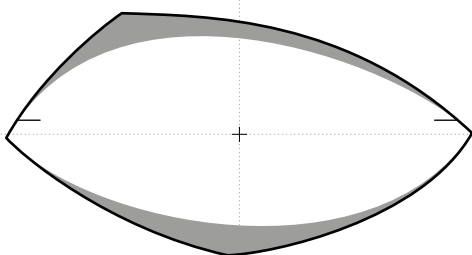

2 mm

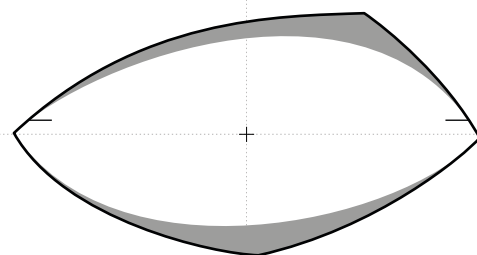

PATRIK

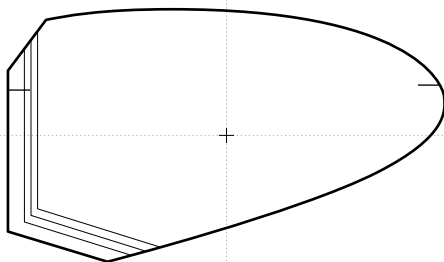

1 mm

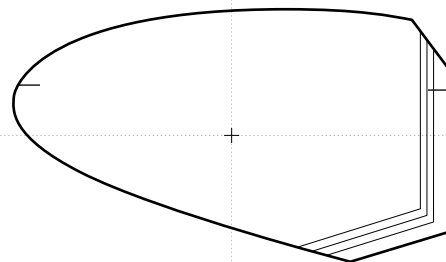

PAVEL

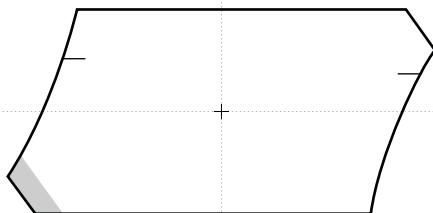

2 mm

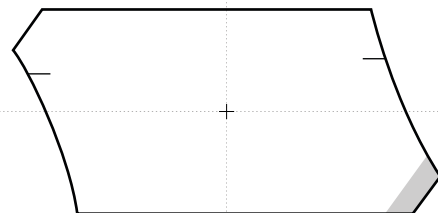

Tyto kreativní tvary brýlových čoček byly navrženy a vyrobeny v ateliéru kreativ při společnosti EYE 2000 s.r.o. a jsou chráněny Úřadem průmyslového vlastnictví jako průmyslový vzor.
These creative glasses lens shapes were designed and produced by atelier kreativ by EYE 2000 s.r.o. company and are patented and protected by the Authority of the Industrial Property.

EYE 2000 s.r.o. / Ohmova 271 / 109 00 Praha 10 / Czech Republic / Provozovna / Polubenská 614 / 468 61 Desná / Czech Republic
T +420 271 961 170 / www.eye2000.cz / info@eye2000.cz



ateliér
kreativ

PAVLINKA

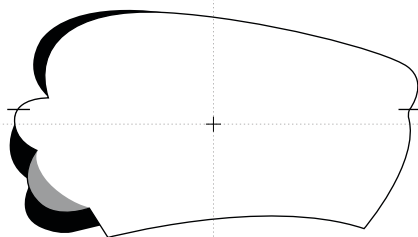

1 mm

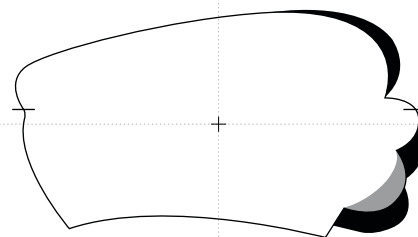

PENELOPA

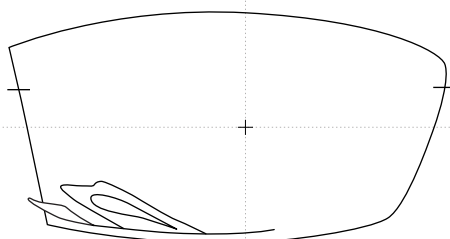

0,5 mm

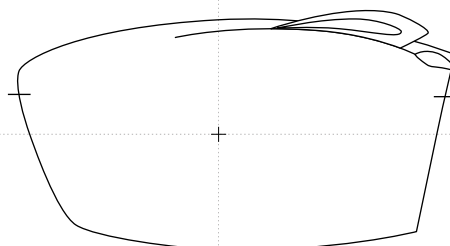

PEPITO

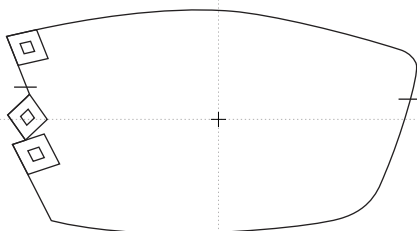

1 mm

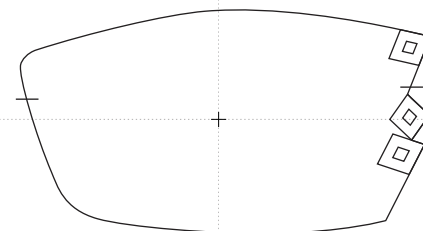

PERSIDA

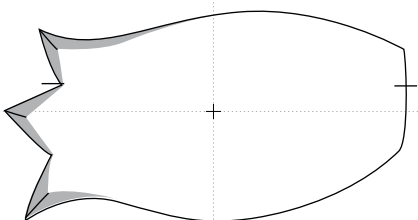

0 mm

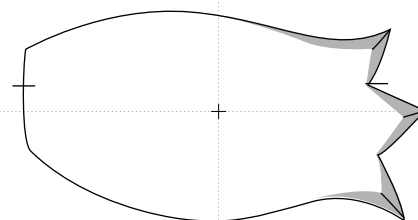

Tyto kreativní tvary brýlových čoček byly navrženy a vyrobeny v ateliéru kreativ při společnosti EYE 2000 s.r.o. a jsou chráněny Úřadem průmyslového vlastnictví jako průmyslový vzor.
These creative glasses lens shapes were designed and produced by ateliér kreativ by EYE 2000 s.r.o. company and are patented and protected by the Authority of the Industrial Property.

EYE 2000 s.r.o. / Ohmova 271 / 109 00 Praha 10 / Czech Republic / Provozovna / Polubenská 614 / 468 61 Desná / Czech Republic
T +420 271 961 170 / www.eye2000.cz / info@eye2000.cz



ateliér
kreativ

PETR

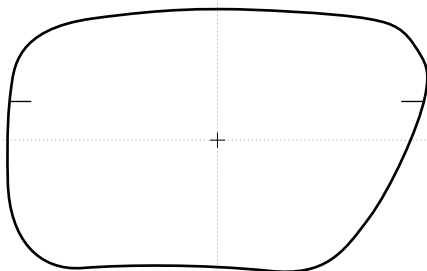

1 mm

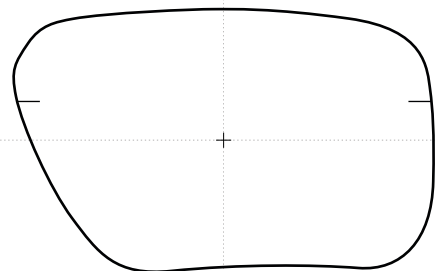

PHOSPHOREA

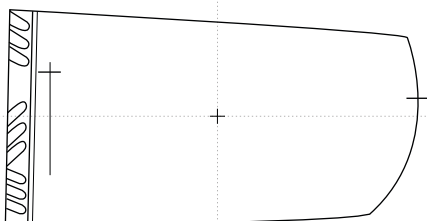

0 mm

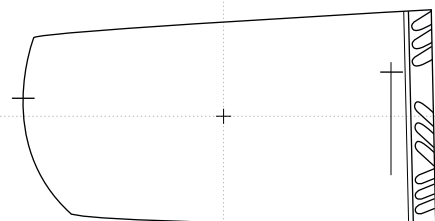

PLUTENIA

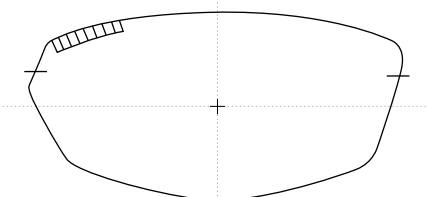

0,5 mm

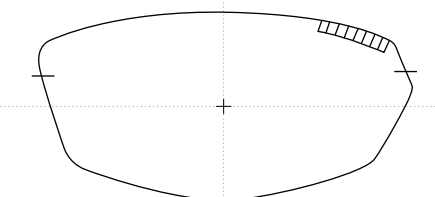

POLONIA

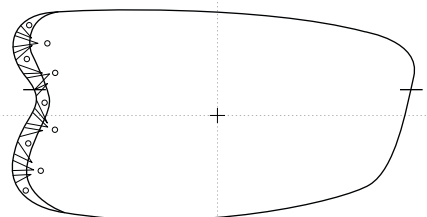

0,5 mm

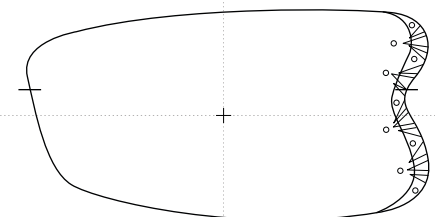

Tyto kreativní tvary brýlových čoček byly navrženy a vyrobeny v ateliéru kreativ při společnosti EYE 2000 s.r.o. a jsou chráněny Úřadem průmyslového vlastnictví jako průmyslový vzor.
These creative glasses lens shapes were designed and produced by ateliér kreativ by EYE 2000 s.r.o. company and are patented and protected by the Authority of the Industrial Property.

EYE 2000 s.r.o. / Ohmova 271 / 109 00 Praha 10 / Czech Republic / Provozovna / Polubenská 614 / 468 61 Desná / Czech Republic
T +420 271 961 170 / www.eye2000.cz / info@eye2000.cz



ateliér
kreativ

POPELKA

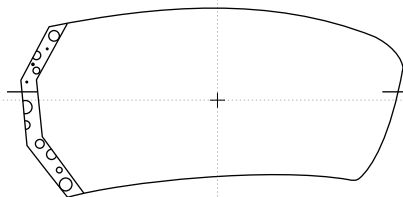

0,5 mm

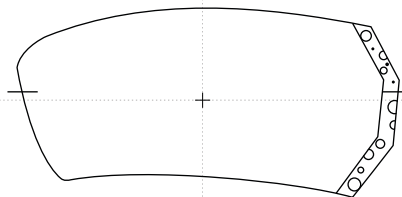

PRISCILA

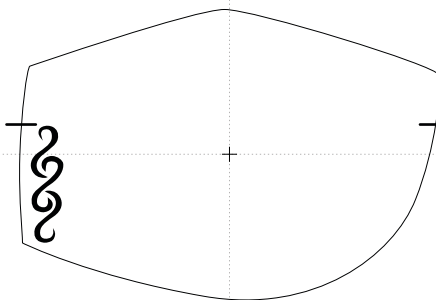

0,5 mm

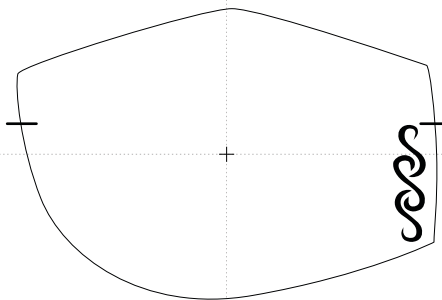

PROKOP

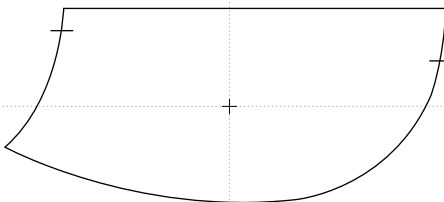

0,5 mm

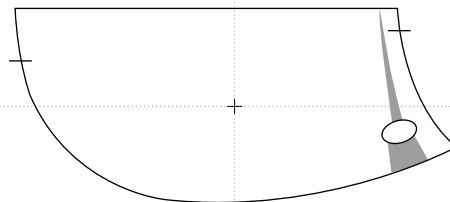

RADANA

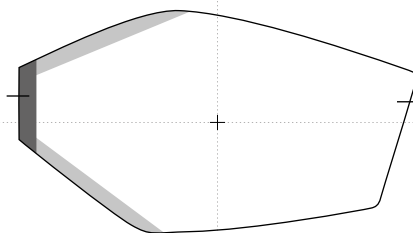

1 mm

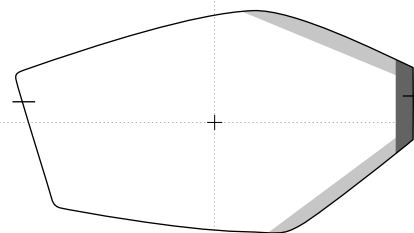

Tyto kreativní tvary brýlových čoček byly navrženy a vyrobeny v ateliéru kreativ při společnosti EYE 2000 s.r.o. a jsou chráněny Úřadem průmyslového vlastnictví jako průmyslový vzor. These creative glasses lens shapes were designed and produced by ateliér kreativ by EYE 2000 s.r.o. company and are patented and protected by the Authority of the Industrial Property.

EYE 2000 s.r.o. / Ohmova 271 / 109 00 Praha 10 / Czech Republic / Provozovna / Polubenská 614 / 468 61 Desná / Czech Republic
T +420 271 961 170 / www.eye2000.cz / info@eye2000.cz



ateliér
kreativ

RADEK

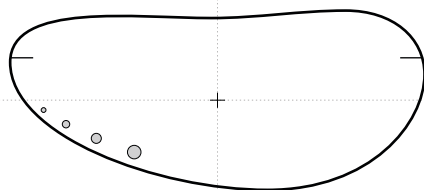

0,5 mm

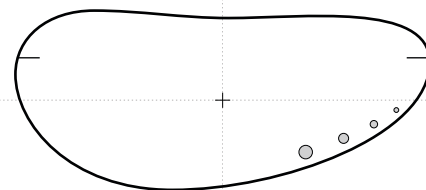

RADIANA

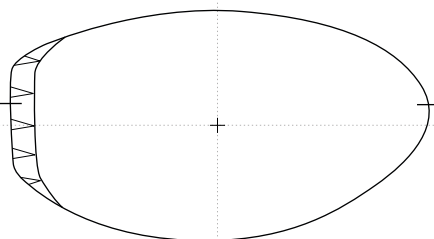

0 mm

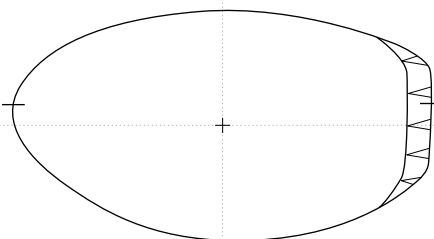

RADUZA

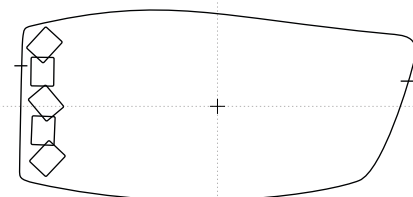

2 mm

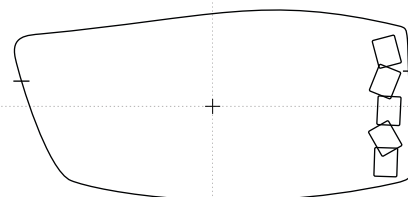

RAFAELA

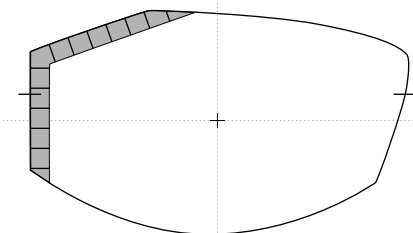

0,5 mm

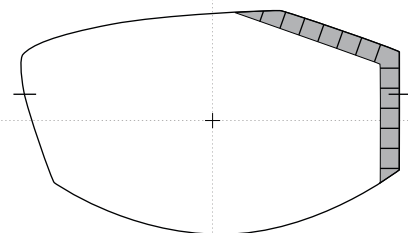

Tyto kreativní tvary brýlových čoček byly navrženy a vyrobeny v ateliéru kreativ při společnosti EYE 2000 s.r.o. a jsou chráněny Úřadem průmyslového vlastnictví jako průmyslový vzor. These creative glasses lens shapes were designed and produced by ateliér kreativ by EYE 2000 s.r.o. company and are patented and protected by the Authority of the Industrial Property.

EYE 2000 s.r.o. / Ohmova 271 / 109 00 Praha 10 / Czech Republic / Provozovna / Polubenská 614 / 468 61 Desná / Czech Republic
T +420 271 961 170 / www.eyeye2000.cz / info@eyeye2000.cz



ateliér
kreativ

RACHEL

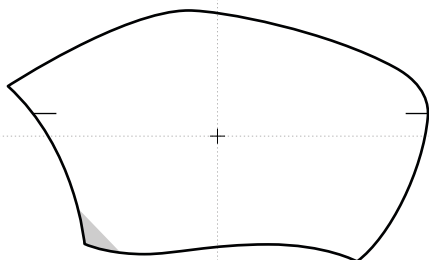

0 mm

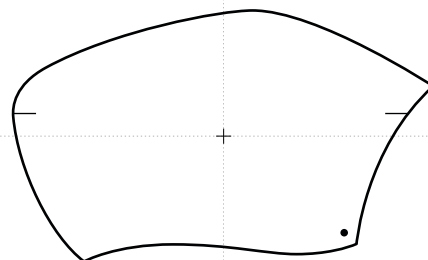

RAJSA

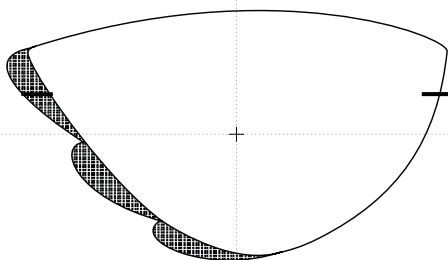

1,2 mm

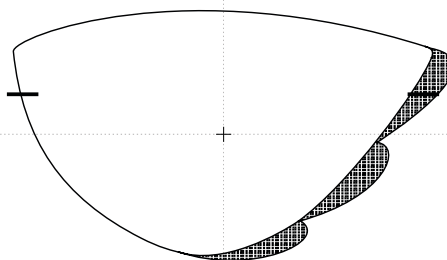

RAK

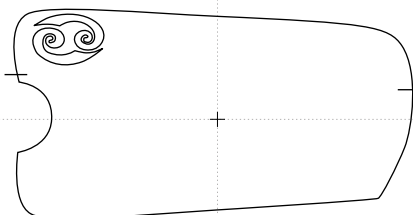

0 mm

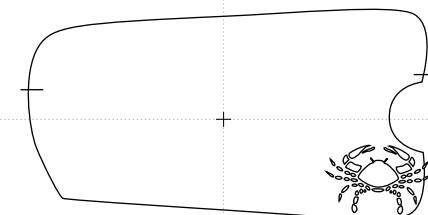

REGINA

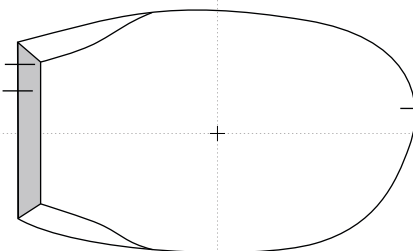

0 mm

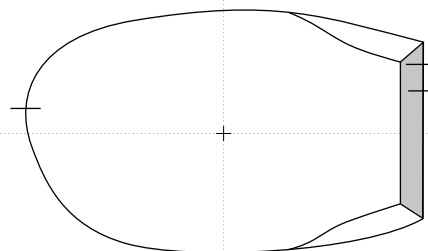

Tyto kreativní tvary brýlových čoček byly navrženy a vyrobeny v ateliéru kreativ při společnosti EYE 2000 s.r.o. a jsou chráněny Úřadem průmyslového vlastnictví jako průmyslový vzor.
These creative glasses lens shapes were designed and produced by ateliér kreativ by EYE 2000 s.r.o. company and are patented and protected by the Authority of the Industrial Property.

EYE 2000 s.r.o. / Ohmova 271 / 109 00 Praha 10 / Czech Republic / Provozovna / Polubenská 614 / 468 61 Desná / Czech Republic
T +420 271 961 170 / www.eye2000.cz / info@eye2000.cz



atelier
kreativ

REMUS

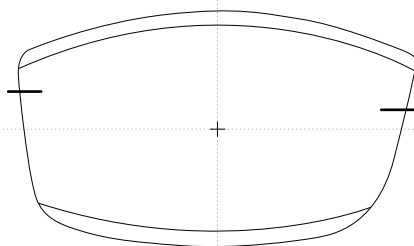

1,4 mm

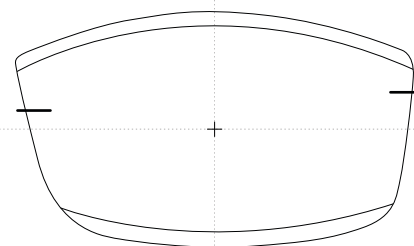

RENATA

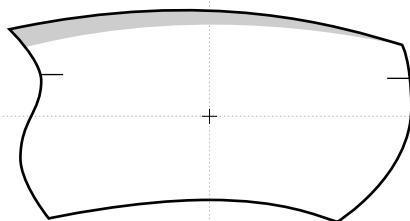

0,5 mm

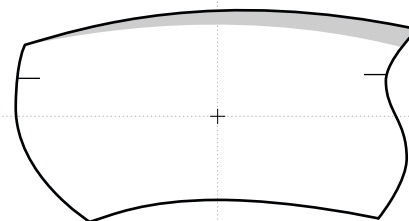

RICHARD

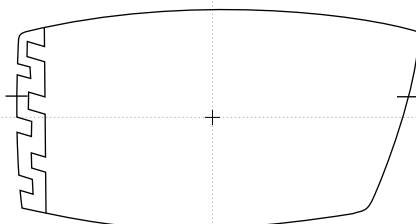

0,5 mm

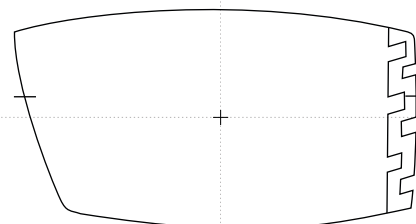

RIJANA

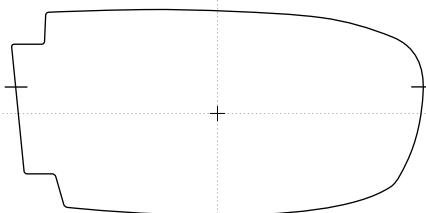

0,5 mm

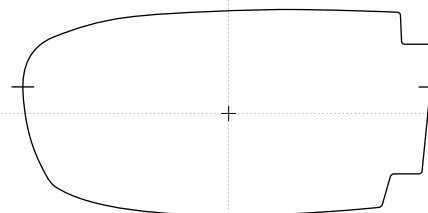

Tyto kreativní tvary brýlových čoček byly navrženy a vyrobeny v ateliéru kreativ při společnosti EYE 2000 s.r.o. a jsou chráněny Úřadem průmyslového vlastnictví jako průmyslový vzor.
These creative glasses lens shapes were designed and produced by atelier kreativ by EYE 2000 s.r.o. company and are patented and protected by the Authority of the Industrial Property.

EYE 2000 s.r.o. / Ohmova 271 / 109 00 Praha 10 / Czech Republic / Provozovna / Polubenská 614 / 468 61 Desná / Czech Republic
T +420 271 961 170 / www.eyeye2000.cz / info@eyeye2000.cz



ateliér
kreativ

ROBIN

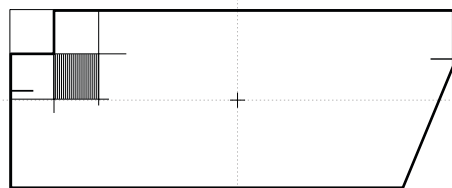

0 mm

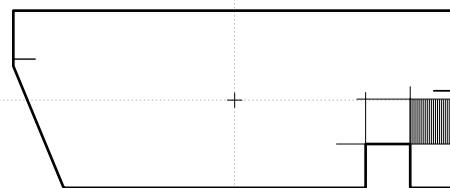

ROMANA

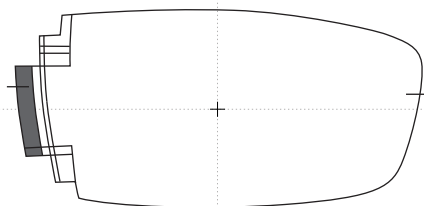

0,5 mm

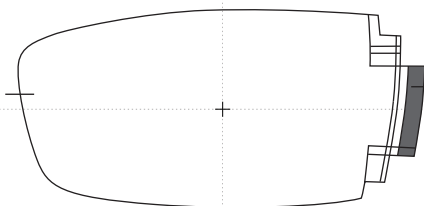

ROSAMUNDA

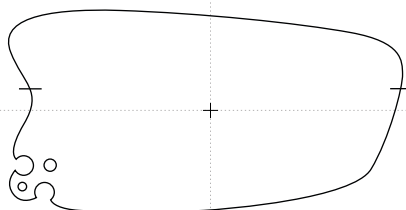

0,5 mm

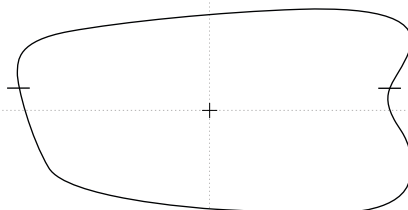

ROZARKA

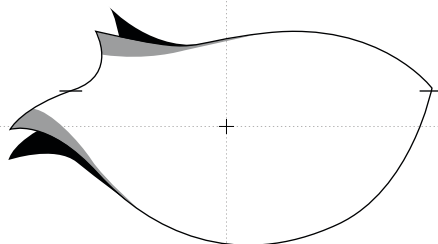

0 mm

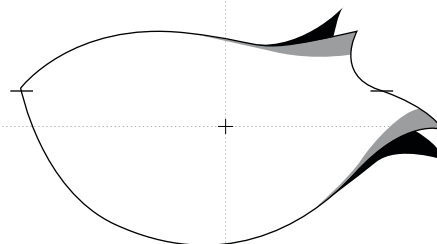

Tyto kreativní tvary brýlových čoček byly navrženy a vyrobeny v ateliéru kreativ při společnosti EYE 2000 s.r.o. a jsou chráněny Úřadem průmyslového vlastnictví jako průmyslový vzor.
These creative glasses lens shapes were designed and produced by ateliér kreativ by EYE 2000 s.r.o. company and are patented and protected by the Authority of the Industrial Property.

EYE 2000 s.r.o. / Ohmova 271 / 109 00 Praha 10 / Czech Republic / Provozovna / Polubenská 614 / 468 61 Desná / Czech Republic
T +420 271 961 170 / www.eye2000.cz / info@eye2000.cz



atelier
kreativ

ROZITA

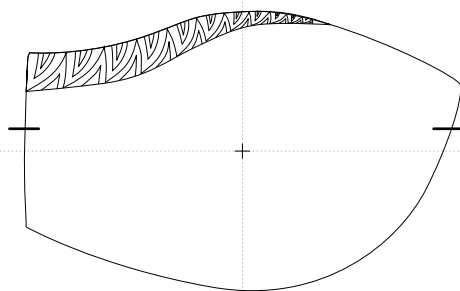

1,2 mm

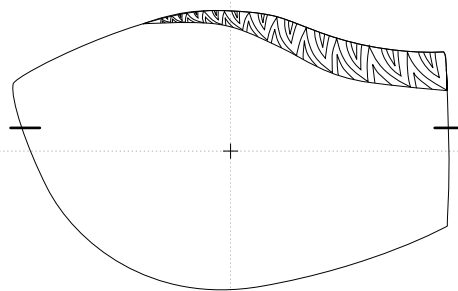

RUBI

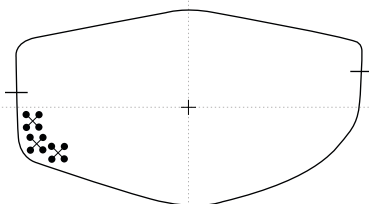

0 mm

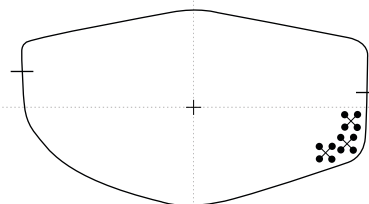

RUFIN

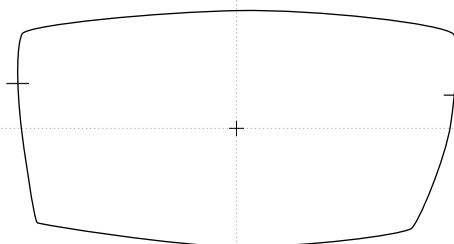

0,5 mm

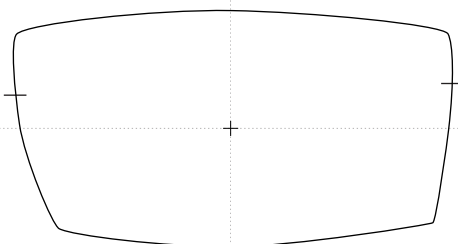

RUT

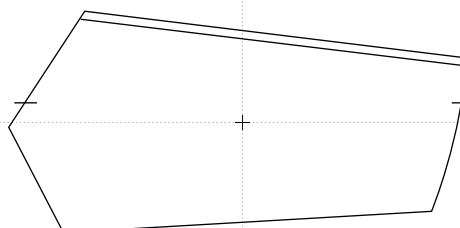

0,5 mm

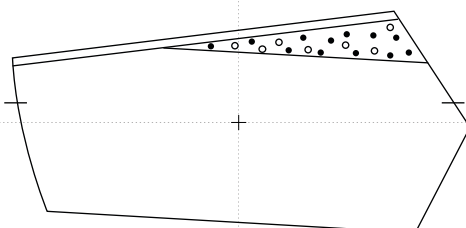

Tyto kreativní tvary brýlových čoček byly navrženy a vyrobeny v ateliéru kreativ při společnosti EYE 2000 s.r.o. a jsou chráněny Úřadem průmyslového vlastnictví jako průmyslový vzor.
These creative glasses lens shapes were designed and produced by atelier kreativ by EYE 2000 s.r.o. company and are patented and protected by the Authority of the Industrial Property.

EYE 2000 s.r.o. / Ohmova 271 / 109 00 Praha 10 / Czech Republic / Provozovna / Polubenská 614 / 468 61 Desná / Czech Republic
T +420 271 961 170 / www.eye2000.cz / info@eye2000.cz



ateliér
kreativ

RYBY

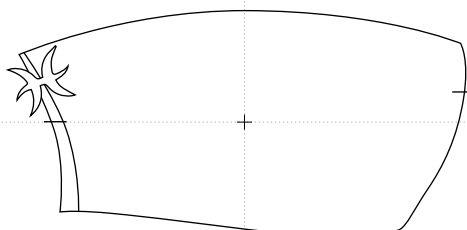

0 mm

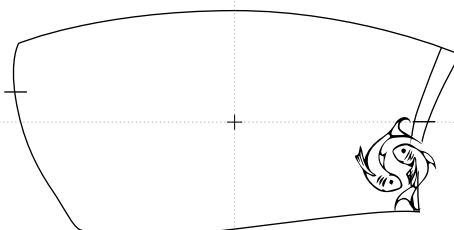

SABINA

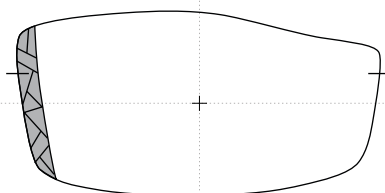

0 mm

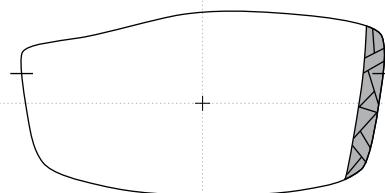

SALOMENA

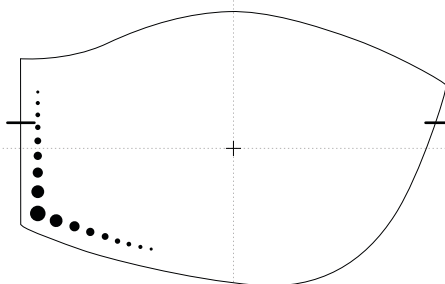

1,4 mm

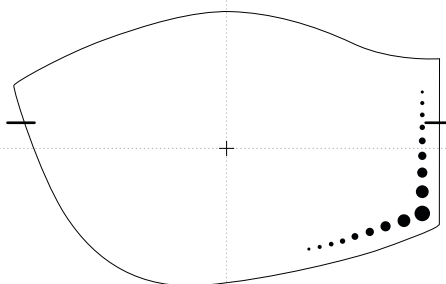

SAMARA

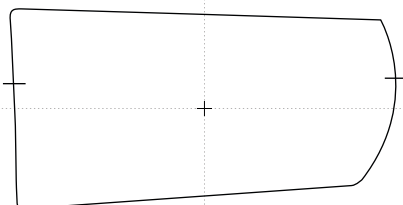

0 mm

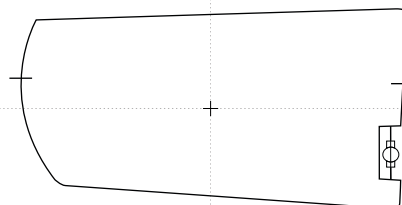

Tyto kreativní tvary brýlových čoček byly navrženy a vyrobeny v ateliéru kreativ při společnosti EYE 2000 s.r.o. a jsou chráněny Úřadem průmyslového vlastnictví jako průmyslový vzor. These creative glasses lens shapes were designed and produced by ateliér kreativ by EYE 2000 s.r.o. company and are patented and protected by the Authority of the Industrial Property.

EYE 2000 s.r.o. / Ohmova 271 / 109 00 Praha 10 / Czech Republic / Provozovna / Polubenská 614 / 468 61 Desná / Czech Republic
T +420 271 961 170 / www.eye2000.cz / info@eye2000.cz



atelier
kreativ

SANDRA

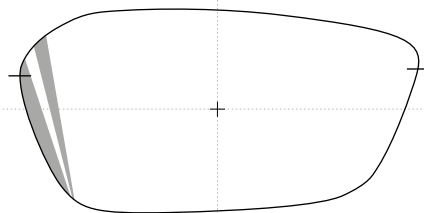

0,25 mm

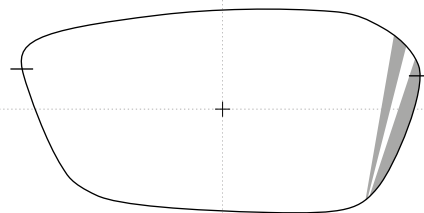

SASKIE

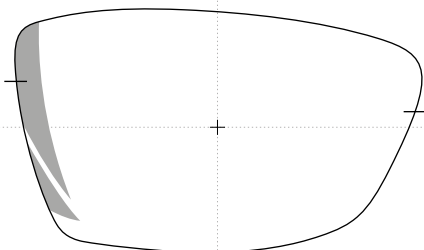

1 mm

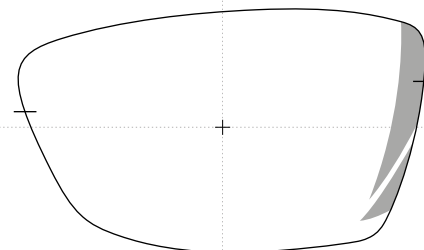

SAVA

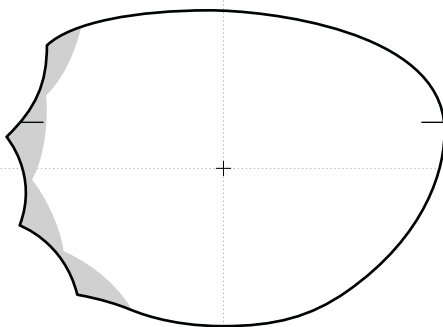

0 mm

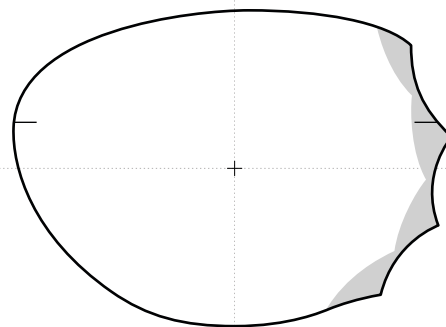

SEDMIKRASKA

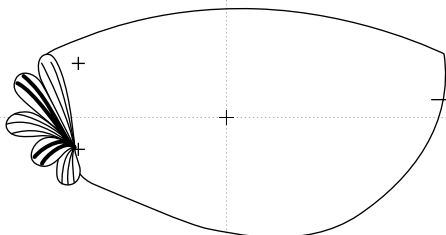

0 mm

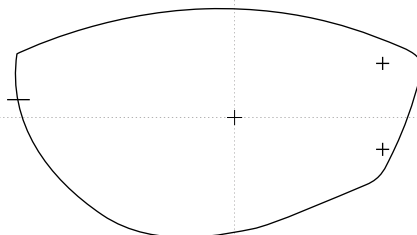

Tyto kreativní tvary brýlových čoček byly navrženy a vyrobeny v ateliéru kreativ při společnosti EYE 2000 s.r.o. a jsou chráněny Úřadem průmyslového vlastnictví jako průmyslový vzor.
These creative glasses lens shapes were designed and produced by atelier kreativ by EYE 2000 s.r.o. company and are patented and protected by the Authority of the Industrial Property.

EYE 2000 s.r.o. / Ohmova 271 / 109 00 Praha 10 / Czech Republic / Provozovna / Polubenská 614 / 468 61 Desná / Czech Republic
T +420 271 961 170 / www.eye2000.cz / info@eye2000.cz



atelier
kreativ

SEDRİK

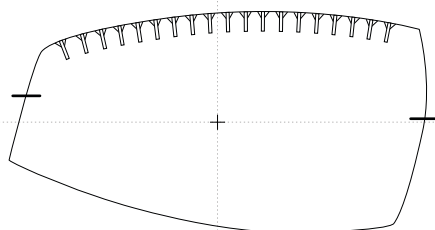

0 mm

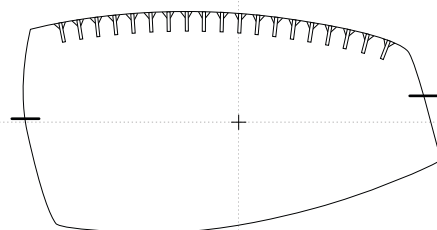

SELENA

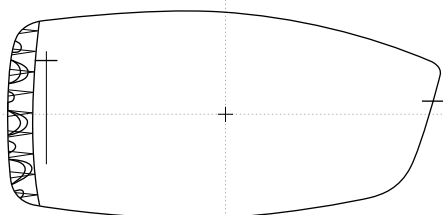

1 mm

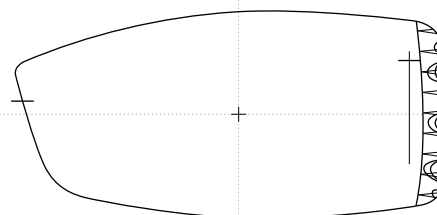

SHARK

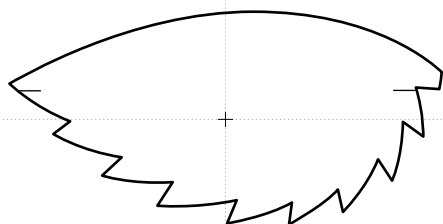

3 mm

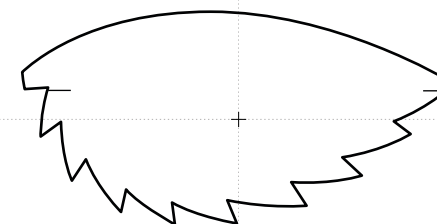

SILICA

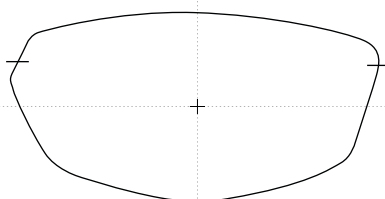

0 mm

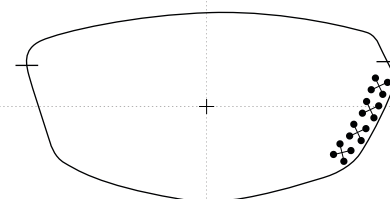

Tyto kreativní tvary brýlových čoček byly navrženy a vyrobeny v ateliéru kreativ při společnosti EYE 2000 s.r.o. a jsou chráněny Úřadem průmyslového vlastnictví jako průmyslový vzor. These creative glasses lens shapes were designed and produced by atelier kreativ by EYE 2000 s.r.o. company and are patented and protected by the Authority of the Industrial Property.

EYE 2000 s.r.o. / Ohmova 271 / 109 00 Praha 10 / Czech Republic / Provozovna / Polubenská 614 / 468 61 Desná / Czech Republic
T +420 271 961 170 / www.eye2000.cz / info@eye2000.cz



ateliér
kreativ

SIMIR

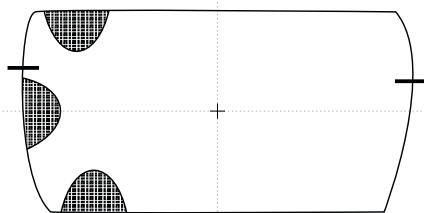

0 mm

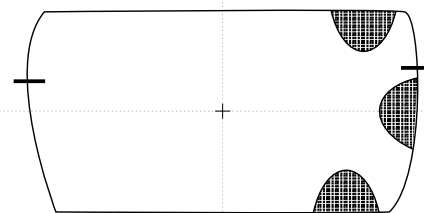

SIMONA

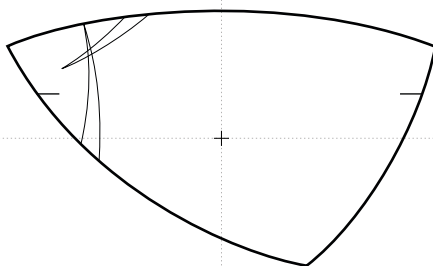

2 mm

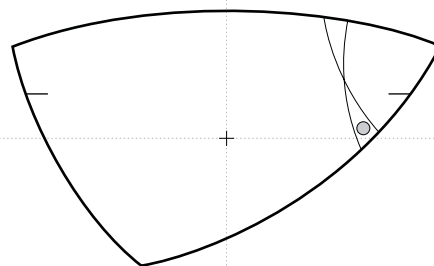

SLAVA

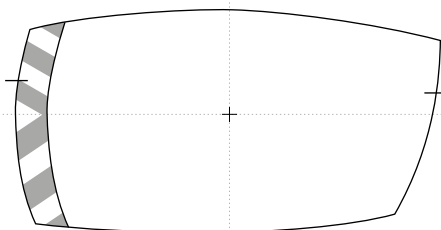

0,25 mm

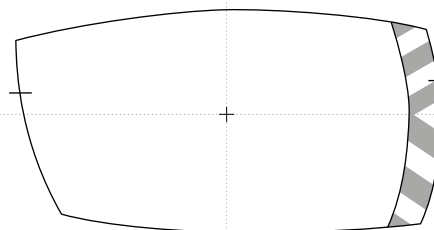

SONA

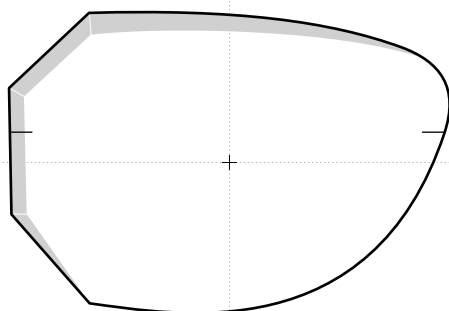

1 mm

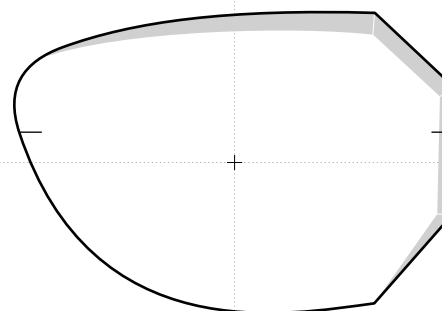

Tyto kreativní tvary brýlových čoček byly navrženy a vyrobeny v ateliéru kreativ při společnosti EYE 2000 s.r.o. a jsou chráněny Úřadem průmyslového vlastnictví jako průmyslový vzor. These creative glasses lens shapes were designed and produced by ateliér kreativ by EYE 2000 s.r.o. company and are patented and protected by the Authority of the Industrial Property.

EYE 2000 s.r.o. / Ohmova 271 / 109 00 Praha 10 / Czech Republic / Provozovna / Polubenská 614 / 468 61 Desná / Czech Republic
T +420 271 961 170 / www.eye2000.cz / info@eye2000.cz



atelier
kreativ

SOPHIA

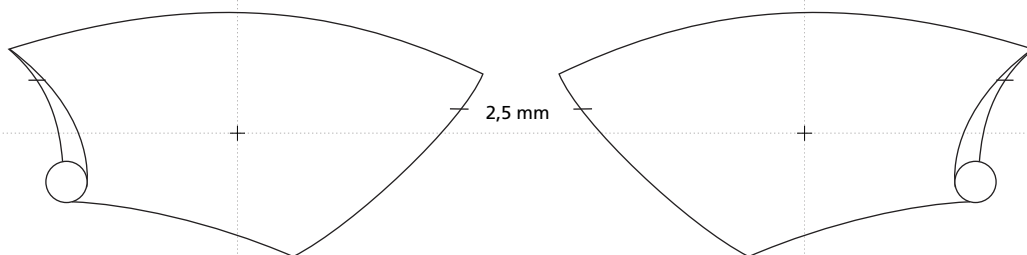

SPIRALY

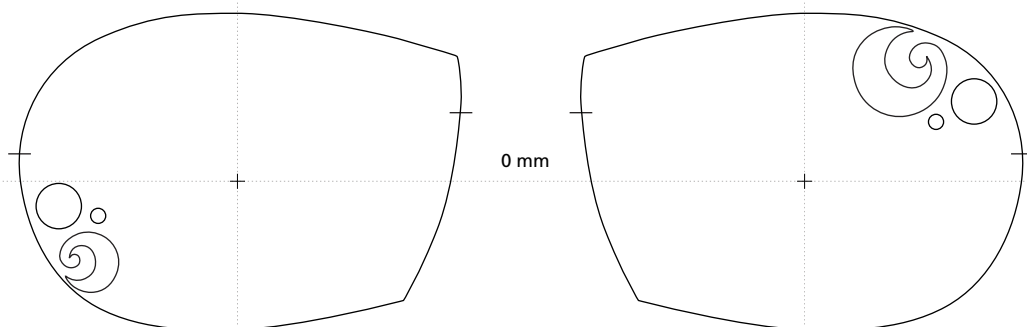

SPIRALY SUN

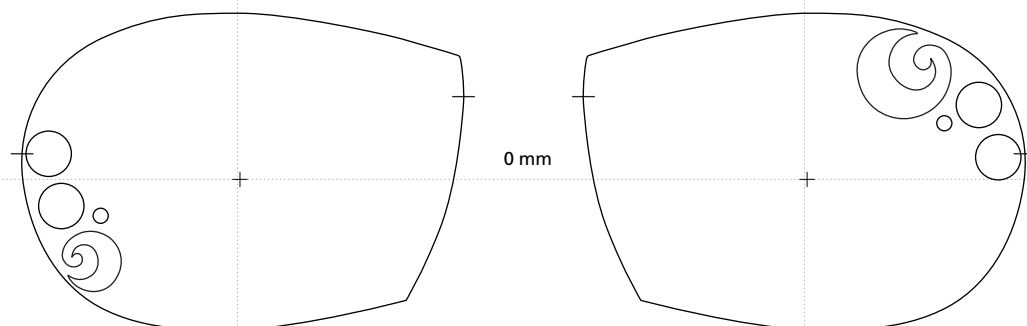

STRONCIA

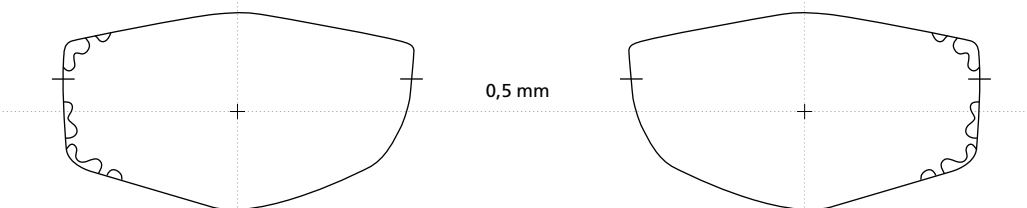

Tyto kreativní tvary brýlových čoček byly navrženy a vyrobeny v ateliéru kreativ při společnosti EYE 2000 s.r.o. a jsou chráněny Úřadem průmyslového vlastnictví jako průmyslový vzor. These creative glasses lens shapes were designed and produced by atelier kreativ by EYE 2000 s.r.o. company and are patented and protected by the Authority of the Industrial Property.

EYE 2000 s.r.o. / Ohmova 271 / 109 00 Praha 10 / Czech Republic / Provozovna / Polubenská 614 / 468 61 Desná / Czech Republic
T +420 271 961 170 / www.eye2000.cz / info@eye2000.cz

STŘELEC

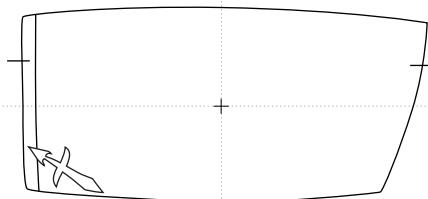

0,5 mm

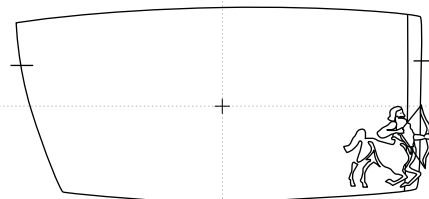

SVATAVA

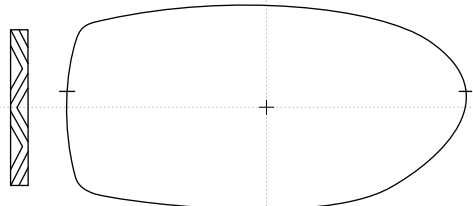

0 mm

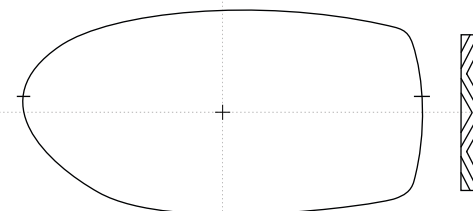

SVETLANA

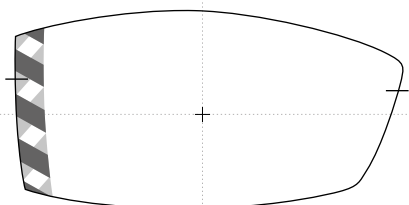

0,5 mm

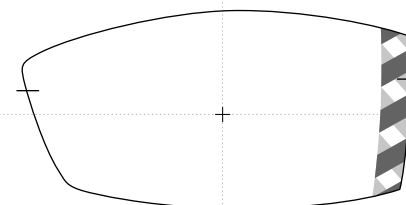

SAKIRA

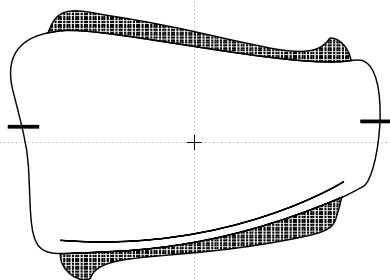

0 mm

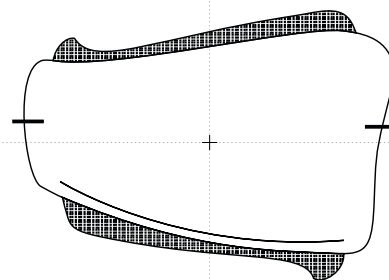



ateliér
kreativ

SARKA

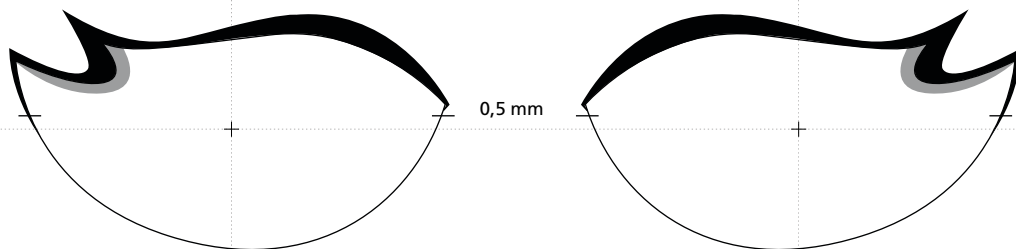

SARLOTA

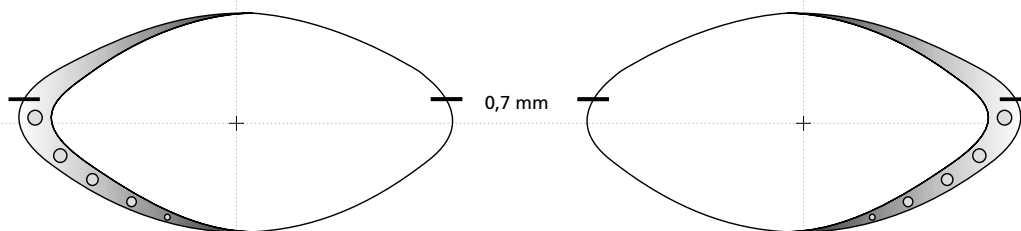

STIR

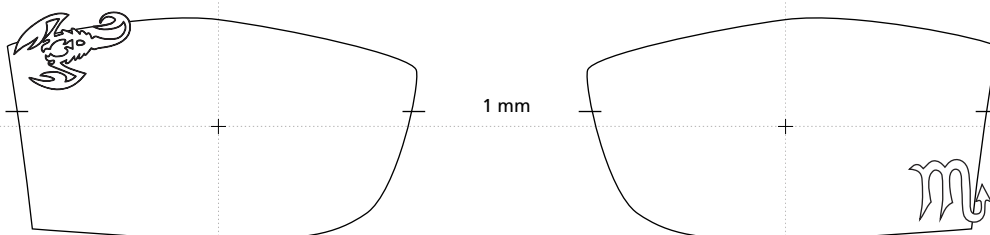

TADEAS

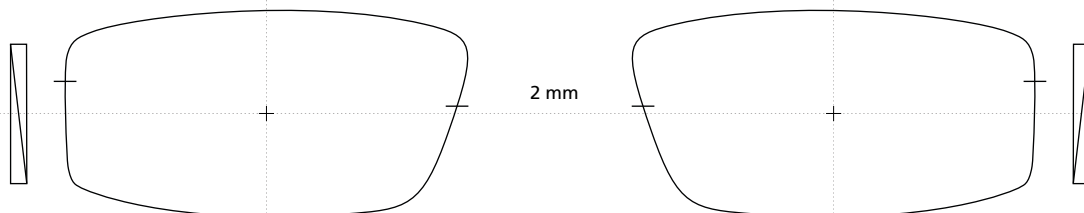

Tyto kreativní tvary brýlových čoček byly navrženy a vyrobeny v ateliéru kreativ při společnosti EYE 2000 s.r.o. a jsou chráněny Úřadem průmyslového vlastnictví jako průmyslový vzor.
These creative glasses lens shapes were designed and produced by ateliér kreativ by EYE 2000 s.r.o. company and are patented and protected by the Authority of the Industrial Property.

EYE 2000 s.r.o. / Ohmova 271 / 109 00 Praha 10 / Czech Republic / Provozovna / Polubenská 614 / 468 61 Desná / Czech Republic
T +420 271 961 170 / www.eyeye2000.cz / info@eyeye2000.cz



atelier
kreativ

TAMARA

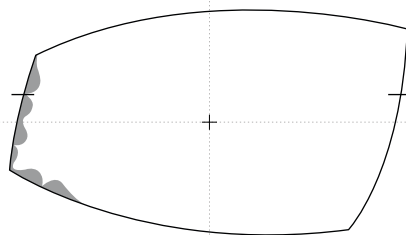

0,5 mm

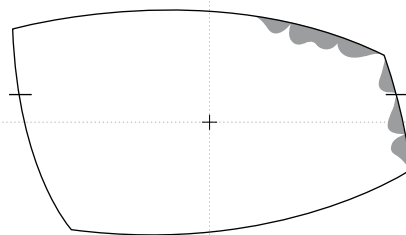

TATTOO ANDEL

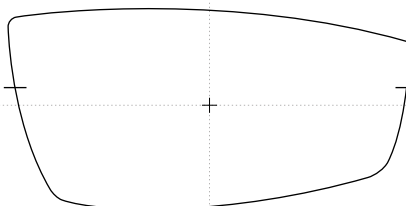

0,5 mm

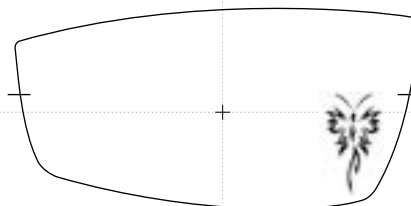

TATTOO DRAK

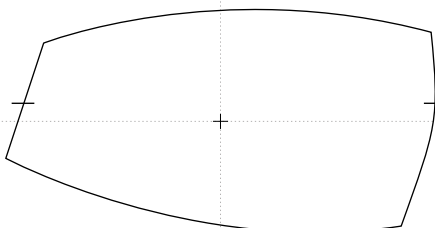

0,5 mm

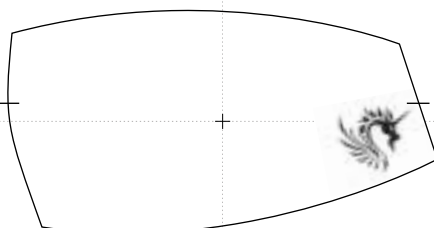

TATTOO DYKA

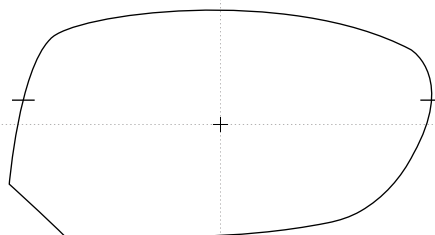

0 mm

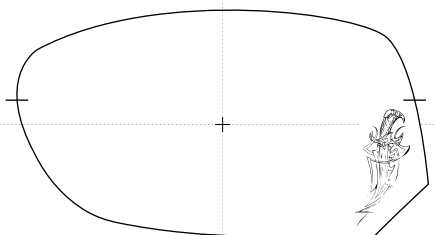

Tyto kreativní tvary brýlových čoček byly navrženy a vyrobeny v ateliéru kreativ při společnosti EYE 2000 s.r.o. a jsou chráněny Úřadem průmyslového vlastnictví jako průmyslový vzor.
These creative glasses lens shapes were designed and produced by atelier kreativ by EYE 2000 s.r.o. company and are patented and protected by the Authority of the Industrial Property.

EYE 2000 s.r.o. / Ohmova 271 / 109 00 Praha 10 / Czech Republic / Provozovna / Polubenská 614 / 468 61 Desná / Czech Republic
T +420 271 961 170 / www.eye2000.cz / info@eye2000.cz

TATTOO GEISHA

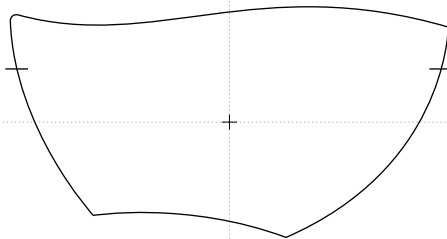

1 mm

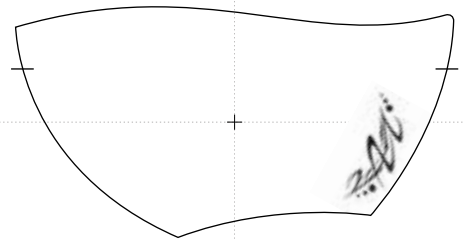

TATTOO HAD

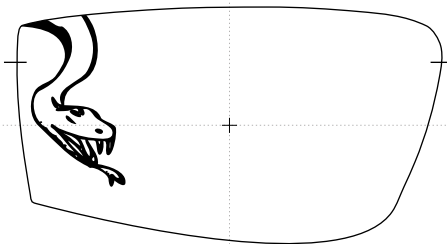

1 mm

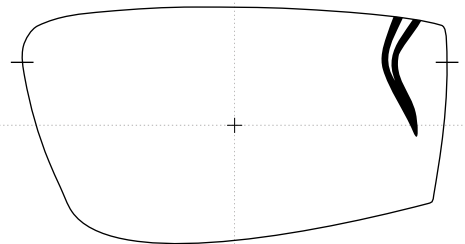

TATTOO JARO

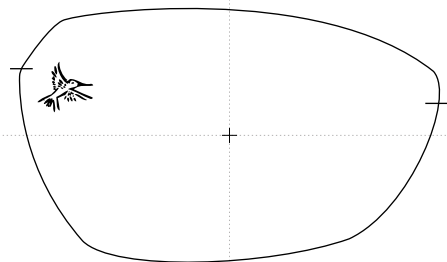

0,25 mm

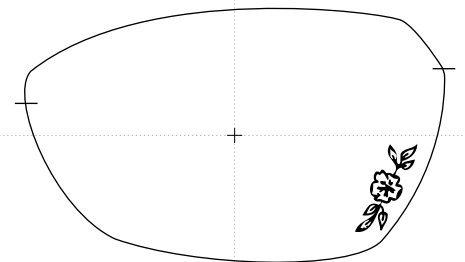

TATTOO JESTERKA

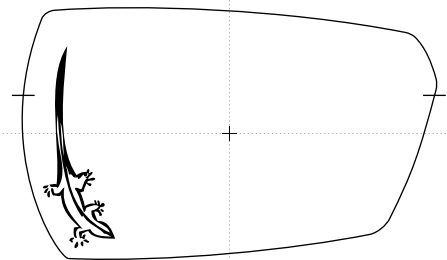

0 mm

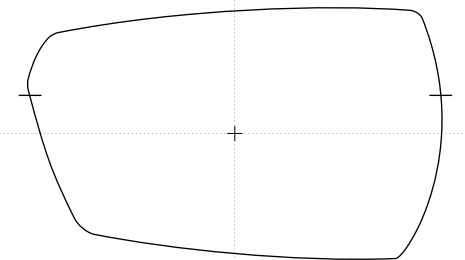

TATTOO KERKA

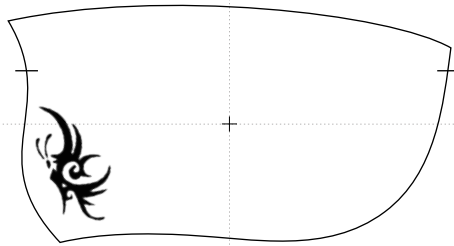

1 mm

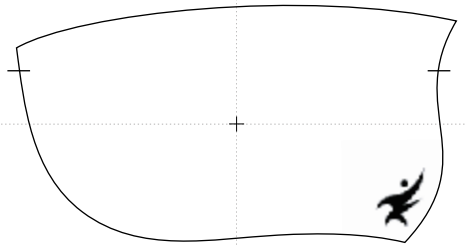

TATTOO KYTKA

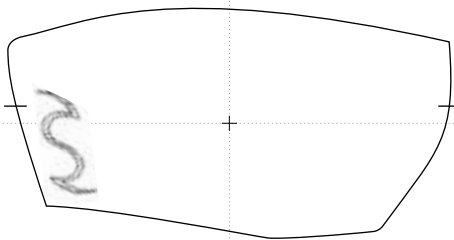

0 mm

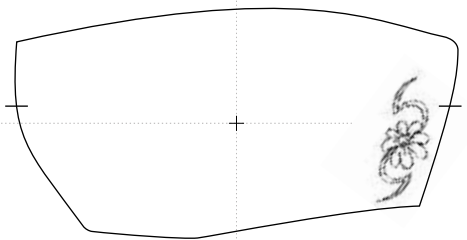

TATTOO MAHON

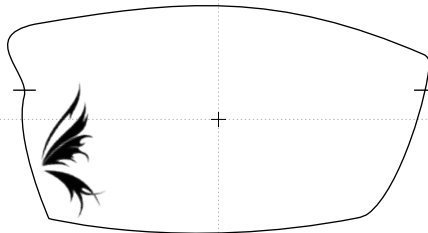

0,5 mm

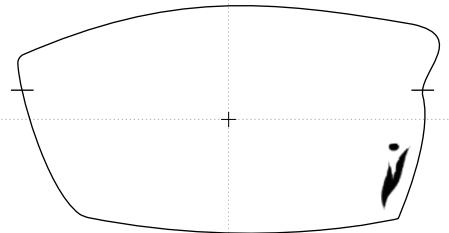

TATTOO MARIHUANA

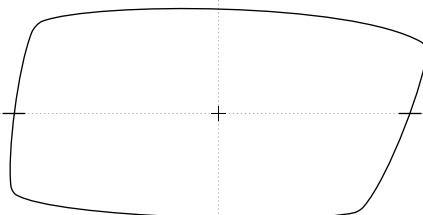

1 mm

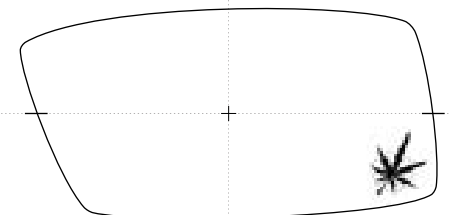

TATTOO OHEN

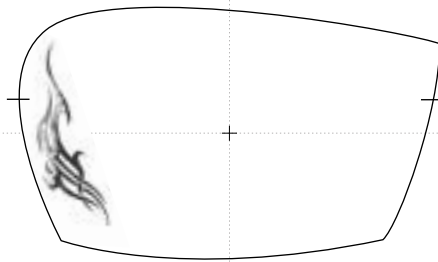

1 mm

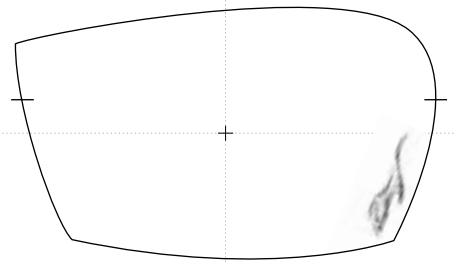

TATTOO PAVOUCEK

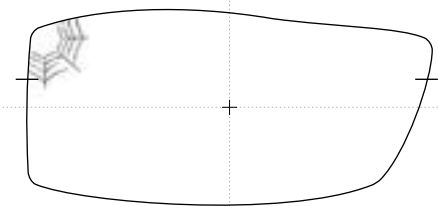

1 mm

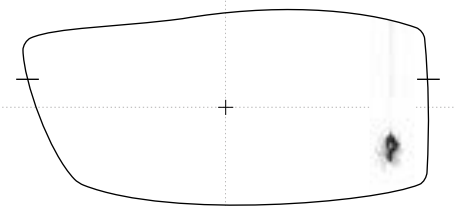

TATTOO SMRTAK

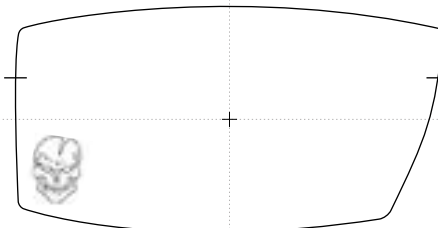

0,1 mm

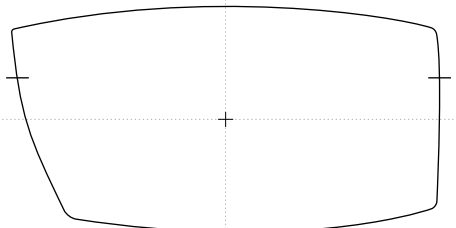

TATTOO SIPEK

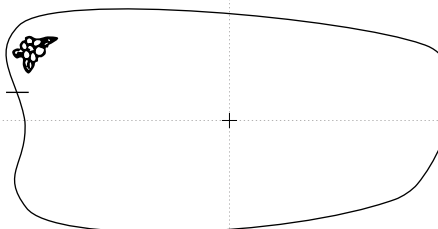

0 mm

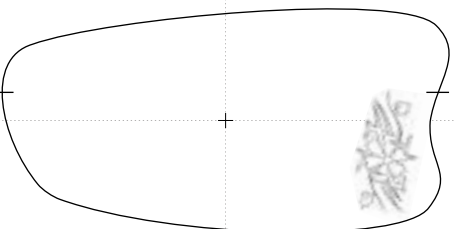



ateliér
kreativ

TATTOO TRILOBIT

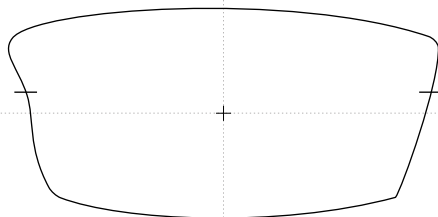

0,5 mm

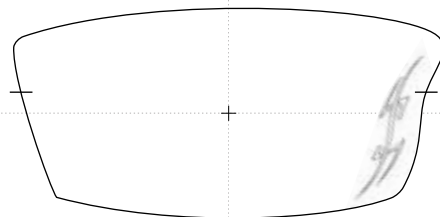

TAZ

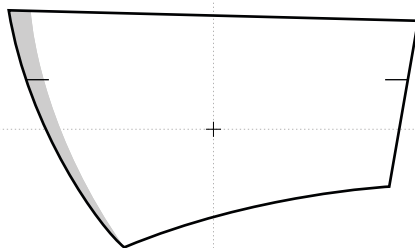

1,5 mm

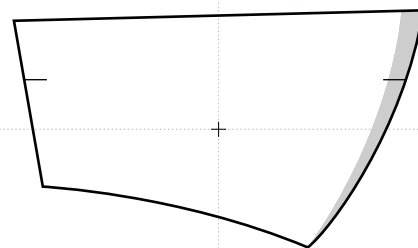

TEODORA

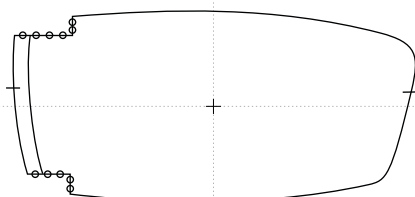

1 mm

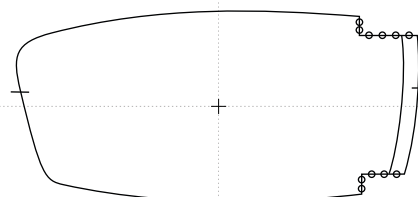

TEREZKA

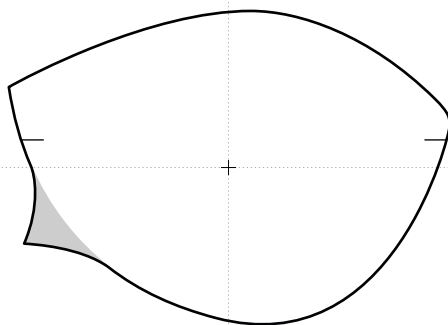

1 mm

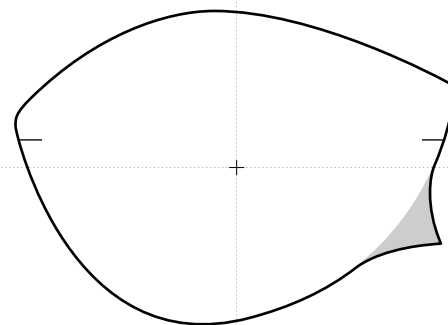

Tyto kreativní tvary brýlových čoček byly navrženy a vyrobeny v ateliéru kreativ při společnosti EYE 2000 s.r.o. a jsou chráněny Úřadem průmyslového vlastnictví jako průmyslový vzor. These creative glasses lens shapes were designed and produced by ateliér kreativ by EYE 2000 s.r.o. company and are patented and protected by the Authority of the Industrial Property.

EYE 2000 s.r.o. / Ohmova 271 / 109 00 Praha 10 / Czech Republic / Provozovna / Polubenská 614 / 468 61 Desná / Czech Republic
T +420 271 961 170 / www.eye2000.cz / info@eye2000.cz



ateliér
kreativ

THOREA

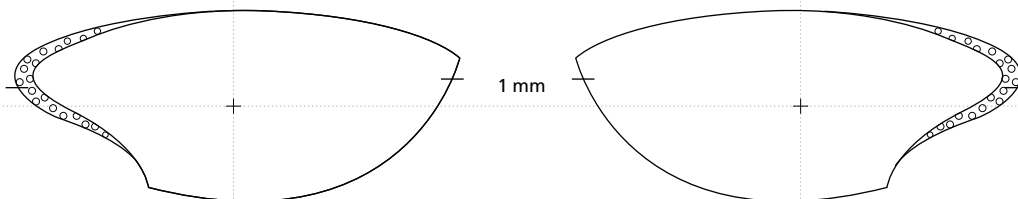

THULIA

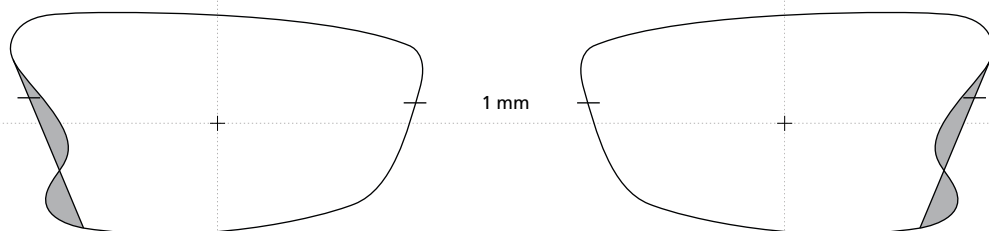

TITANA

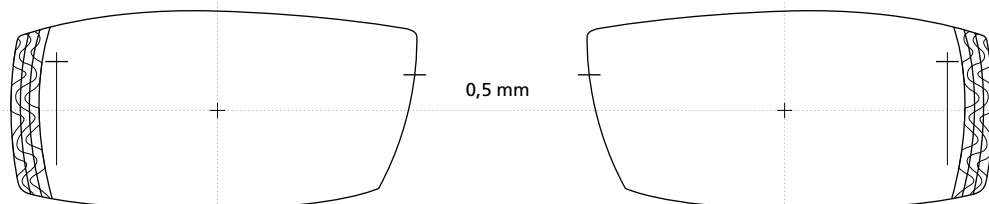

TOMISLAVA

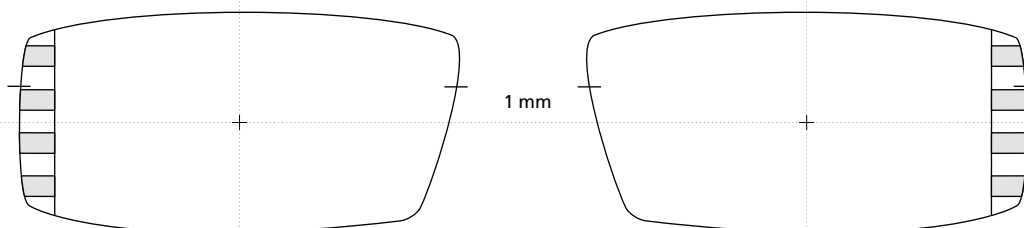

Tyto kreativní tvary brýlových čoček byly navrženy a vyrobeny v ateliéru kreativ při společnosti EYE 2000 s.r.o. a jsou chráněny Úřadem průmyslového vlastnictví jako průmyslový vzor.
These creative glasses lens shapes were designed and produced by ateliér kreativ by EYE 2000 s.r.o. company and are patented and protected by the Authority of the Industrial Property.

EYE 2000 s.r.o. / Ohmova 271 / 109 00 Praha 10 / Czech Republic / Provozovna / Polubenská 614 / 468 61 Desná / Czech Republic
T +420 271 961 170 / www.eye2000.cz / info@eye2000.cz



ateliér
kreativ

TOSKA

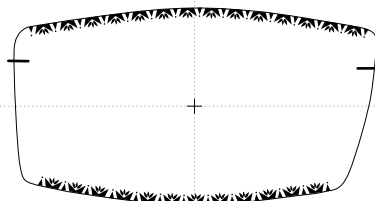

0 mm

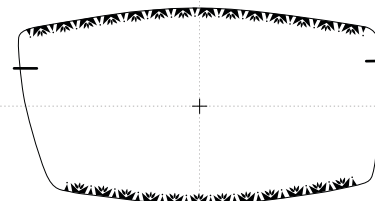

TRAVA

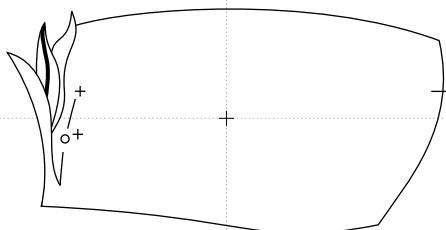

0 mm

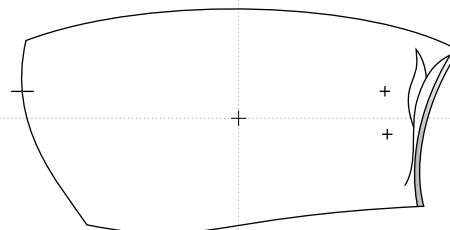

TRIDIA

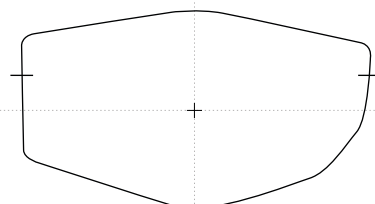

0,5 mm

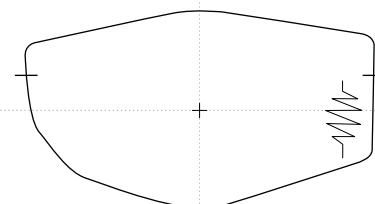

TULIPAN

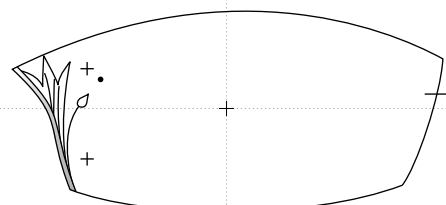

0,5 mm

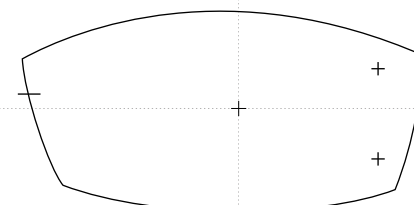

Tyto kreativní tvary brýlových čoček byly navrženy a vyrobeny v ateliéru kreativ při společnosti EYE 2000 s.r.o. a jsou chráněny Úřadem průmyslového vlastnictví jako průmyslový vzor. These creative glasses lens shapes were designed and produced by ateliér kreativ by EYE 2000 s.r.o. company and are patented and protected by the Authority of the Industrial Property.

EYE 2000 s.r.o. / Ohmova 271 / 109 00 Praha 10 / Czech Republic / Provozovna / Polubenská 614 / 468 61 Desná / Czech Republic
T +420 271 961 170 / www.eye2000.cz / info@eye2000.cz



atelier
kreativ

URANIA

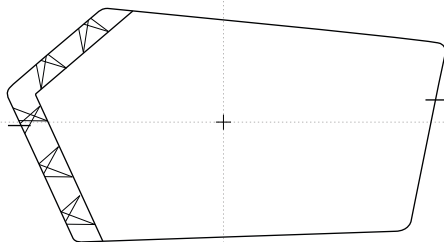

1,5 mm

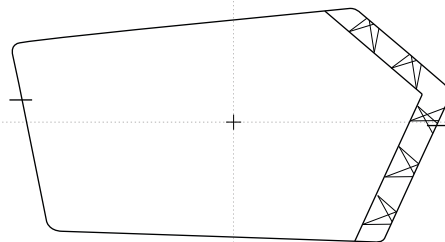

VAHY

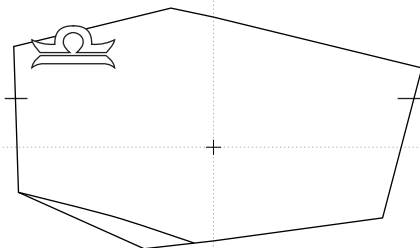

1 mm

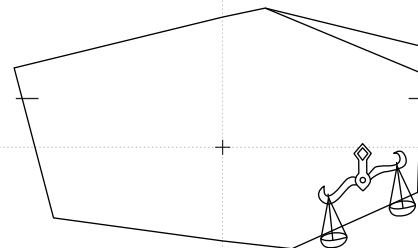

VALERIE

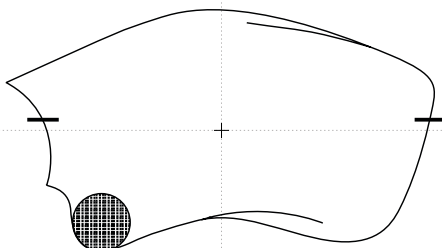

0,5 mm

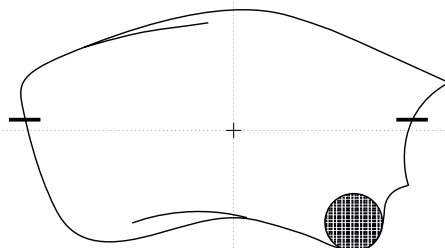

VANDA

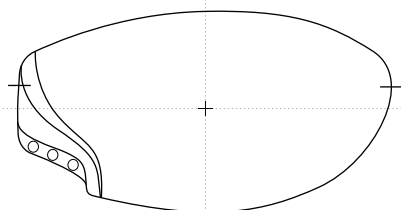

0 mm

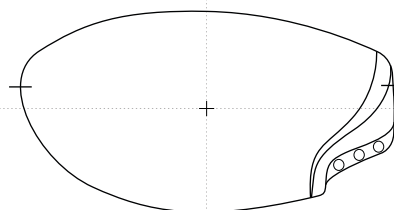

Tyto kreativní tvary brýlových čoček byly navrženy a vyrobeny v ateliéru kreativ při společnosti EYE 2000 s.r.o. a jsou chráněny Úřadem průmyslového vlastnictví jako průmyslový vzor. These creative glasses lens shapes were designed and produced by atelier kreativ by EYE 2000 s.r.o. company and are patented and protected by the Authority of the Industrial Property.

EYE 2000 s.r.o. / Ohmova 271 / 109 00 Praha 10 / Czech Republic / Provozovna / Polubenská 614 / 468 61 Desná / Czech Republic
T +420 271 961 170 / www.eye2000.cz / info@eye2000.cz



ateliér
kreativ

VANESA

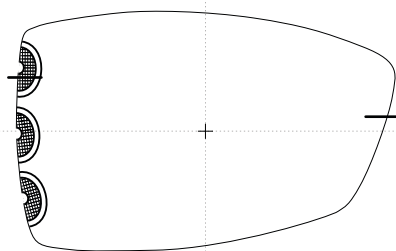

1 mm

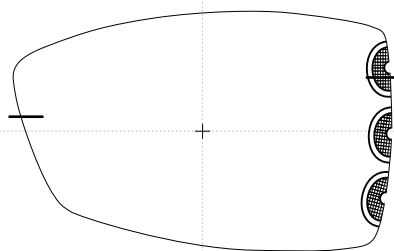

VECERNICE

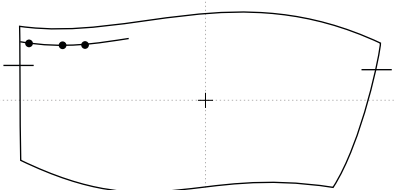

0,5 mm

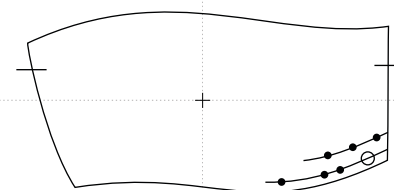

VENDULKA

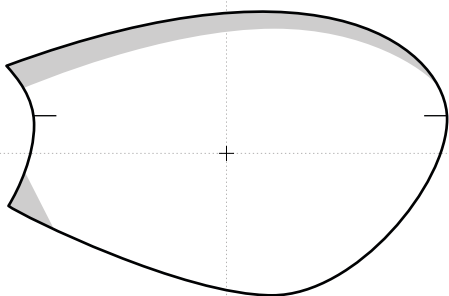

0 mm

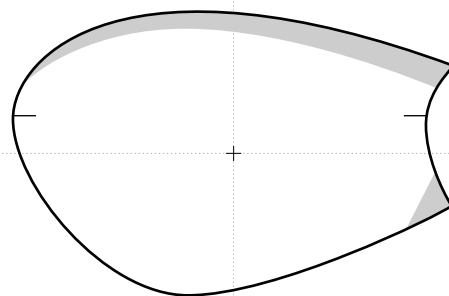

VERUNKA

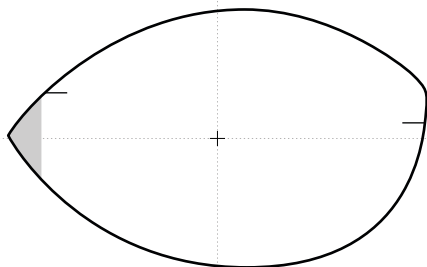

0,5 mm

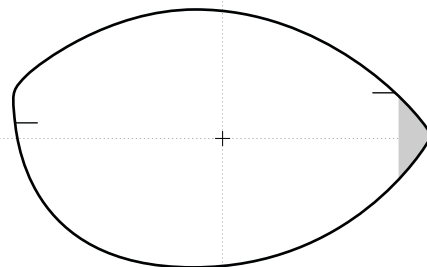

Tyto kreativní tvary brýlových čoček byly navrženy a vyrobeny v ateliéru kreativ při společnosti EYE 2000 s.r.o. a jsou chráněny Úřadem průmyslového vlastnictví jako průmyslový vzor. These creative glasses lens shapes were designed and produced by ateliér kreativ by EYE 2000 s.r.o. company and are patented and protected by the Authority of the Industrial Property.

EYE 2000 s.r.o. / Ohmova 271 / 109 00 Praha 10 / Czech Republic / Provozovna / Polubenská 614 / 468 61 Desná / Czech Republic
T +420 271 961 170 / www.eyeye2000.cz / info@eyeye2000.cz



ateliér
kreativ

VIKTORIE

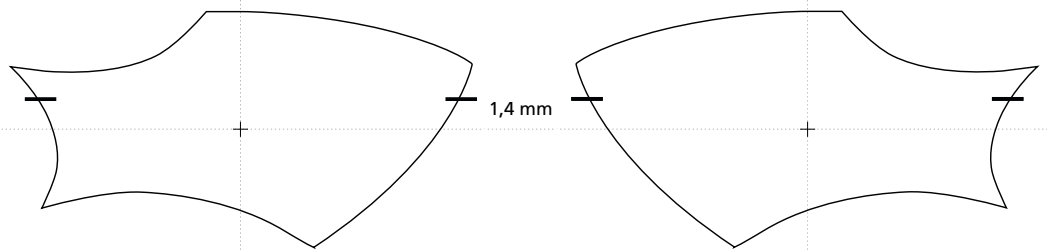

VILEMINA

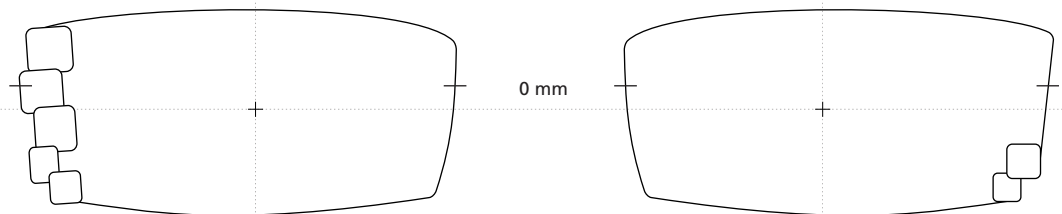

VINCENT

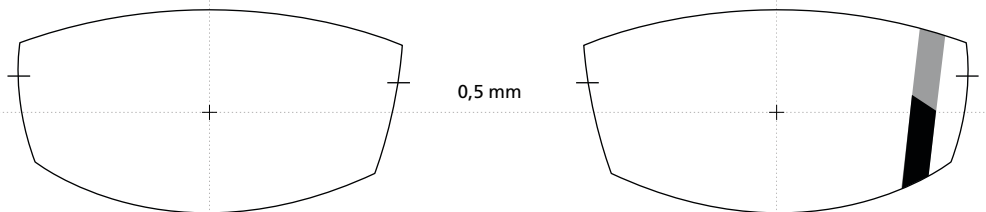

VIOLA

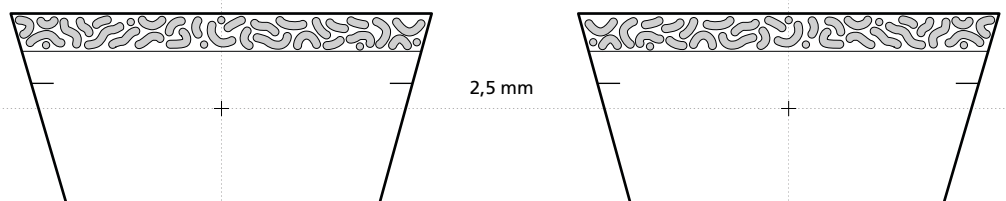

Tyto kreativní tvary brýlových čoček byly navrženy a vyrobeny v ateliéru kreativ při společnosti EYE 2000 s.r.o. a jsou chráněny Úřadem průmyslového vlastnictví jako průmyslový vzor.
These creative glasses lens shapes were designed and produced by ateliér kreativ by EYE 2000 s.r.o. company and are patented and protected by the Authority of the Industrial Property.

EYE 2000 s.r.o. / Ohmova 271 / 109 00 Praha 10 / Czech Republic / Provozovna / Polubenská 614 / 468 61 Desná / Czech Republic
T +420 271 961 170 / www.eye2000.cz / info@eye2000.cz



ateliér
kreativ

VIT

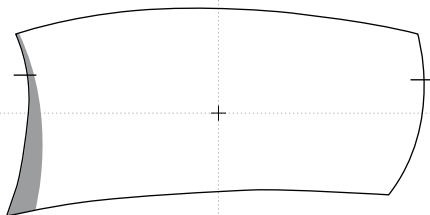

0 mm

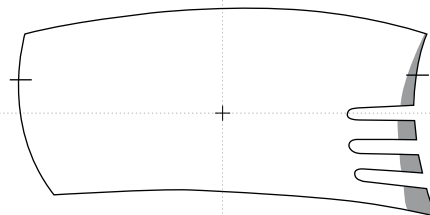

VODNAR

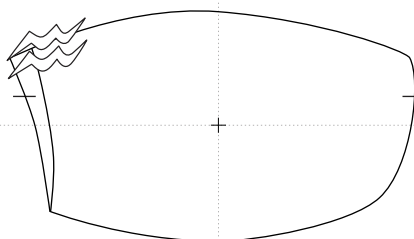

0 mm

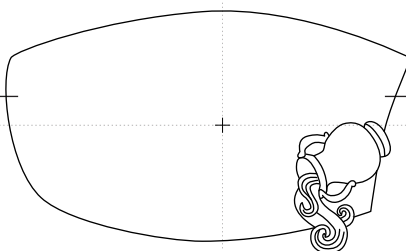

VOJTECH

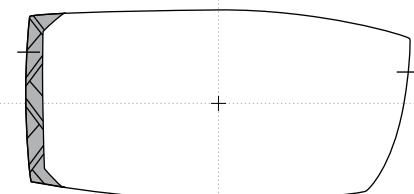

0 mm

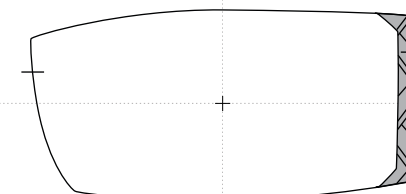

WALDEMAR

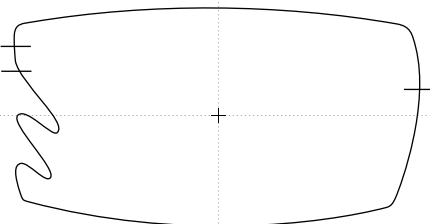

0 mm

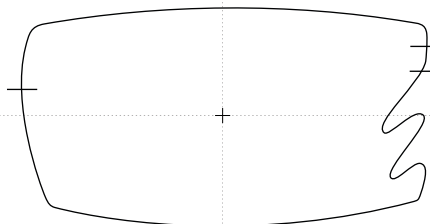

Tyto kreativní tvary brýlových čoček byly navrženy a vyrobeny v ateliéru kreativ při společnosti EYE 2000 s.r.o. a jsou chráněny Úřadem průmyslového vlastnictví jako průmyslový vzor.
These creative glasses lens shapes were designed and produced by ateliér kreativ by EYE 2000 s.r.o. company and are patented and protected by the Authority of the Industrial Property.

EYE 2000 s.r.o. / Ohmova 271 / 109 00 Praha 10 / Czech Republic / Provozovna / Polubenská 614 / 468 61 Desná / Czech Republic
T +420 271 961 170 / www.eye2000.cz / info@eye2000.cz



ateliér
kreativ

WOLF

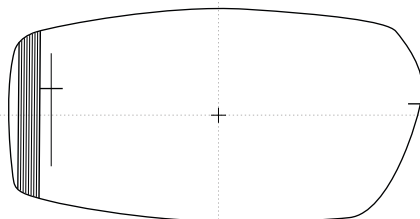

0,5 mm

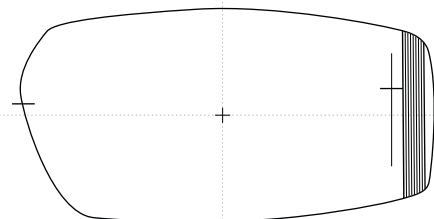

XENIE

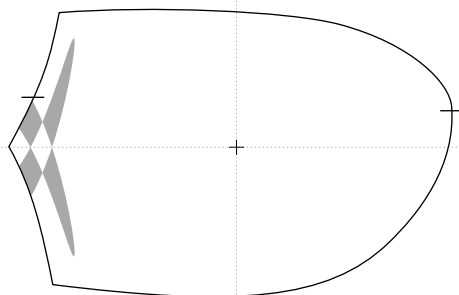

0 mm

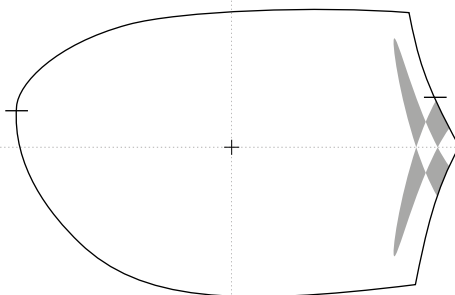

ZAIRA

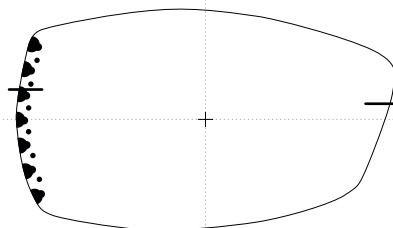

0,7 mm

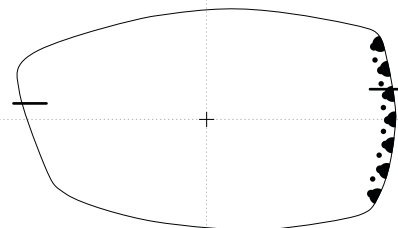

ZDENKA

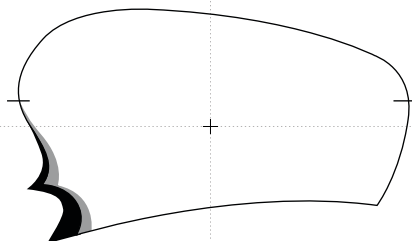

0 mm

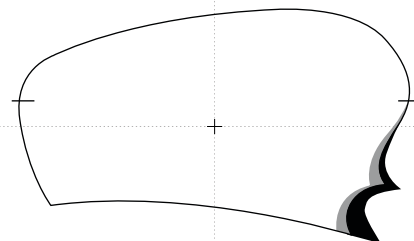

Tyto kreativní tvary brýlových čoček byly navrženy a vyrobeny v ateliéru kreativ při společnosti EYE 2000 s.r.o. a jsou chráněny Úřadem průmyslového vlastnictví jako průmyslový vzor.
These creative glasses lens shapes were designed and produced by ateliér kreativ by EYE 2000 s.r.o. company and are patented and protected by the Authority of the Industrial Property.

EYE 2000 s.r.o. / Ohmova 271 / 109 00 Praha 10 / Czech Republic / Provozovna / Polubenská 614 / 468 61 Desná / Czech Republic
T +420 271 961 170 / www.eyeye2000.cz / info@eyeye2000.cz



ateliér
kreativ

ZIKMUND

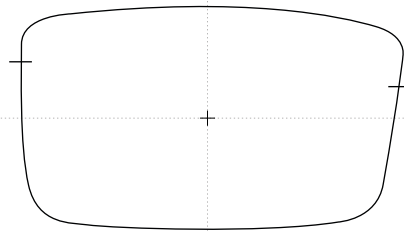

0,5 mm

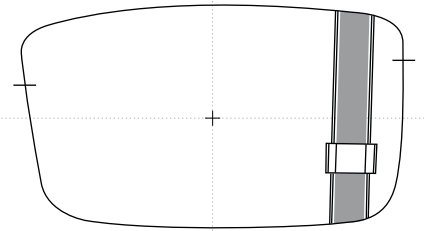

ZINA

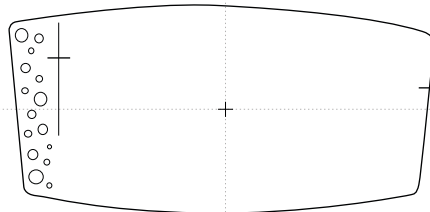

0,5 mm

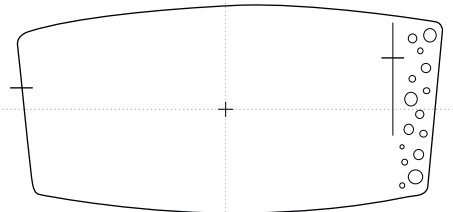

ZLATA

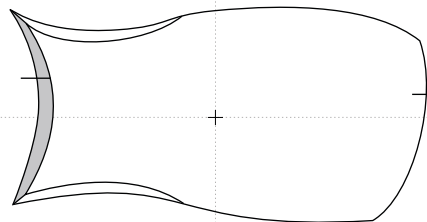

0 mm

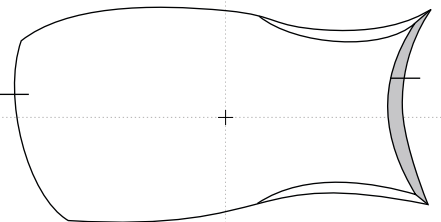

ZLATOVLASKA

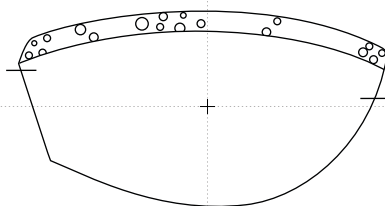

1 mm

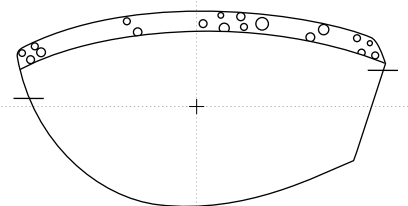

Tyto kreativní tvary brýlových čoček byly navrženy a vyrobeny v ateliéru kreativ při společnosti EYE 2000 s.r.o. a jsou chráněny Úřadem průmyslového vlastnictví jako průmyslový vzor.
These creative glasses lens shapes were designed and produced by ateliér kreativ by EYE 2000 s.r.o. company and are patented and protected by the Authority of the Industrial Property.

EYE 2000 s.r.o. / Ohmova 271 / 109 00 Praha 10 / Czech Republic / Provozovna / Polubenská 614 / 468 61 Desná / Czech Republic
T +420 271 961 170 / www.eye2000.cz / info@eye2000.cz



ateliér
kreativ

ZOE

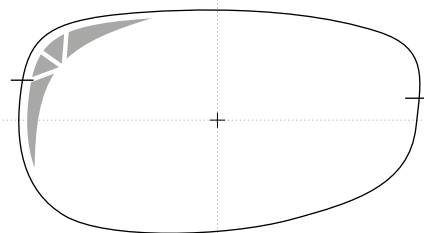

0 mm

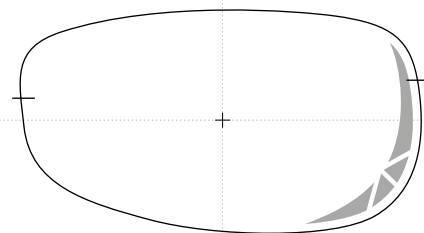

ZUZANA

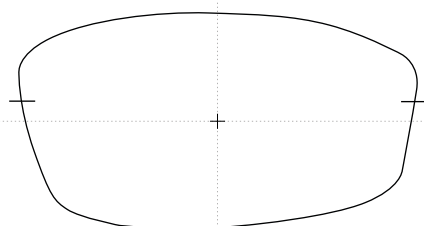

0,5 mm

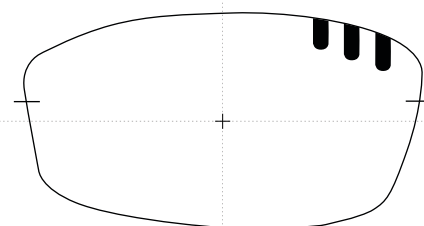

ZAKLINA

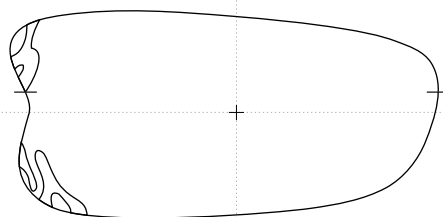

0 mm

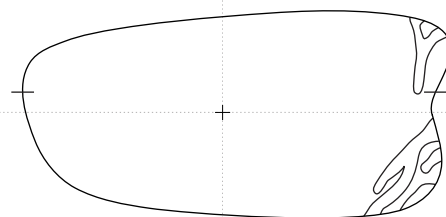

ZANETA

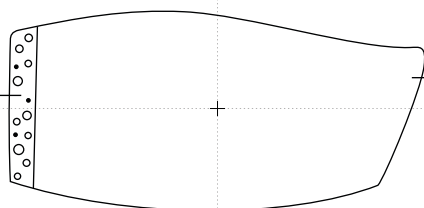

0 mm

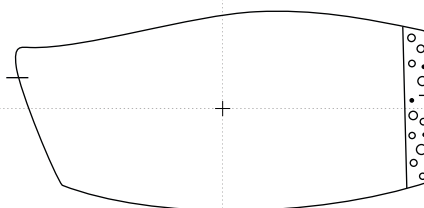

Tyto kreativní tvary brýlových čoček byly navrženy a vyrobeny v ateliéru kreativ při společnosti EYE 2000 s.r.o. a jsou chráněny Úřadem průmyslového vlastnictví jako průmyslový vzor. These creative glasses lens shapes were designed and produced by ateliér kreativ by EYE 2000 s.r.o. company and are patented and protected by the Authority of the Industrial Property.

EYE 2000 s.r.o. / Ohmova 271 / 109 00 Praha 10 / Czech Republic / Provozovna / Polubenská 614 / 468 61 Desná / Czech Republic
T +420 271 961 170 / www.eye2000.cz / info@eye2000.cz